

High Performance Power Entry Module with Switch



- Rated currents up to 10 A
- High quality 2-pole rocker switch
- Optional reduced leakage current versions (A/B type)
- Complies with IEC/EN 60601-1
- Snap-in versions (S type)
- High attenuation performance



Performance indicators

Attenuation performance



Approvals



The FN 9266 power entry module combines an IEC inlet, mains filter with very high filter attenuation based on nano crystalline material selection and a switch in a small form factor. Choosing FN 9266 product line brings you rapid availability of a standard filter associated with the necessary safety acceptances. Standard IEC connector filters are a practical solution helping you to pass EMI system approval in a short time. A wide selection on amperage ratings, mounting possibilities and filters for medical applications (acc. to IEC 60601-1 with low leakage current and high performance) are designed to offer you the desired solution.

Features and benefits

- Excellent conducted attenuation performance, based on chokes with high saturation resistance and good thermal behavior
- High quality 2-pole rocker switch for all-pole disconnection
- Faston terminals for easy assembly
- FN 9266 B versions comply with the requirements of 1MOP acc. to IEC/EN 60601-1 for creepage and clearance, leakage current and high potential testing
- As flange mount and snap-in types available

Typical applications

- Medical electrical devices (MD) and In-Vitro Diagnostic (IVD) medical devices
- Portable electrical and electronic equipment
- EDP and office equipment
- Single-phase power supplies
- Switch-mode power supplies
- Test and measurement equipment

Technical specifications

Operating voltage	250 VAC, 50/60 Hz
Operating frequency	DC to 400 Hz
Rated currents	1 to 10 A @ 40°C max.
High potential test voltage	P → PE 2000 VAC for 2 sec (Standard) P → PE 2500 VAC for 2 sec (B-types) P → N 760 VAC for 2 sec
Protection category	IP 40 according to IEC 60529
Temperature range (operation and storage)	-25°C to +85°C (25/85/21)
Design corresponding to	UL 60939-3, CSA Std C22.2 No. 8, IEC/EN 60939-3, GB/T 15287, GB/T 15288
Flammability corresponding to	Inlet plastic: UL 94 V-0 Switch plastic: UL 94 V-0
MTBF @ Rated amb. Temp./Voltage (Mil-HB-217F)	2,100,000 hours
Rocker switch description	
Function	2-pole, dark not illuminated Marking I – 0
Electrical specifications	Inrush current 100 A 50,000 on-off operations for 10 A according to EN 610581-1
Switch ratings	
Europe (ENEC)	10 A (4 A), 250 VAC* 5E4 16 A (4 A), 250 VAC* 1E4
USA (UL)	20 A, 125 VAC 1 HP; 250 VAC 2 HP;

* Value in () relates to the inductive current charge: $\cos\phi = 0.65$

Typical electrical schematic

FN 9266 (B types without Y-capacitors)

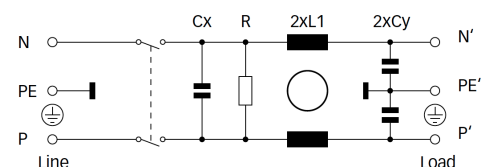

Filter selection table

	Rated current @ 40°C	Leakage current* @ 250 VAC/50 Hz (@ 120 VAC/60 Hz)	Inductance** L	Capacitance**		Resistor** R	Output connections	Weight
				Cx	Cy			
	[A]	[mA]	[mH]	[μF]	[nF]	[kΩ]		[g]
FN 9266-1-06	1	0.31 (0.18)	40	0.15	2.2	1000	-06	55
FN 9266-2-06	2	0.31 (0.18)	20	0.15	2.2	1000	-06	55
FN 9266-4-06	4	0.31 (0.18)	7	0.15	2.2	1000	-06	55
FN 9266-6-06	6	0.31 (0.18)	3	0.15	2.2	1000	-06	55
FN 9266-10-06	10	0.31 (0.18)	1.15	0.15	2.2	1000	-06	55
FN 9266A-1-06	1	0.07 (0.04)	40	0.15	0.47	1000	-06	55
FN 9266A-2-06	2	0.07 (0.04)	20	0.15	0.47	1000	-06	55
FN 9266A-4-06	4	0.07 (0.04)	7	0.15	0.47	1000	-06	55
FN 9266A-6-06	6	0.07 (0.04)	3	0.15	0.47	1000	-06	55
FN 9266A-10-06	10	0.07 (0.04)	1.15	0.15	0.47	1000	-06	55
FN 9266B-1-06	1	0.00	40	0.15		1000	-06	55
FN 9266B-2-06	2	0.00	20	0.15		1000	-06	55
FN 9266B-4-06	4	0.00	7	0.15		1000	-06	55
FN 9266B-6-06	6	0.00	3	0.15		1000	-06	55
FN9266B-10-06	10	0.00	1.15	0.15		1000	-06	55



* Leakage current under normal operating conditions (acc. to IEC60939-3). Note: if the neutral line is interrupted, worst case leakage could reach twice this level.

** Tolerances apply: Inductance: -30/+50%, Capacitance: ±20%, Resistance: ±10%

Product selector

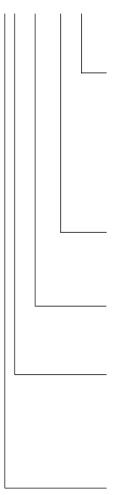
FN 9266xx-yy-yy-y



- Blank: Snap-in range for S version only
- 20: Snap-in range 0.6 to 1.5mm
- 30: Snap-in range 1.6 to 2.5mm
- 06: Snap-in range 2.6 to 3.5mm
- 06: Faston 6.3 x 0.8mm (spade/soldering)
- 1 to 10: Rated current
- Blank: Standard version
- A: Safety version
- B: Medical version (without Y-capacitor)
-  Blank: Standard housing with mounting flanges
-  S: Snap-in version, snapper on vertical side

For example: FN 9266-1-06, FN 9266 SB-10-06

Typical filter attenuation

Per CISPR 17; DM (differential mode)=50 Ω/50 Ω sym; CM (common mode)=50 Ω/50 Ω asym

FN 9266 Standard Type 1 A

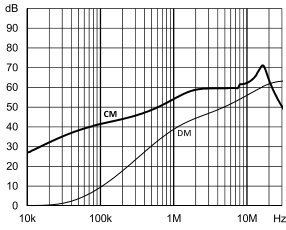

FN 9266 A Type 1 A

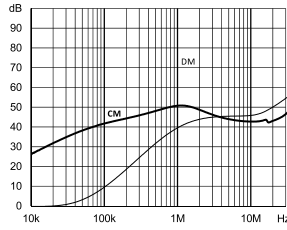

FN 9266 B Type 1 A

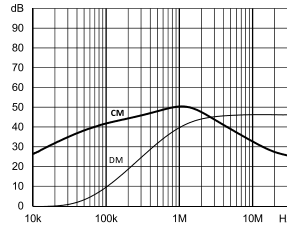

FN 9266 Standard Type 2 A

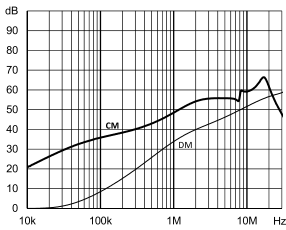

FN 9266 A Type 2 A

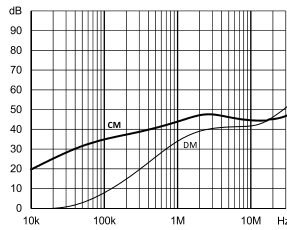

FN 9266 B Type 2 A

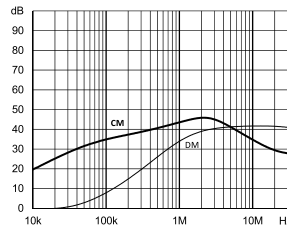

FN 9266 Standard Type 4 A

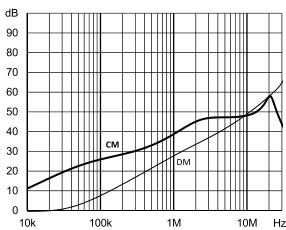

FN 9266 A Type 4 A

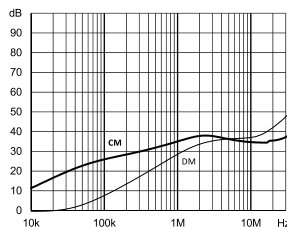

FN 9266 B Type 4 A

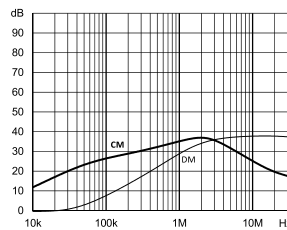

FN 9266 Standard Type 6 A

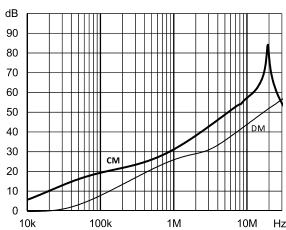

FN 9266 A Type 6 A

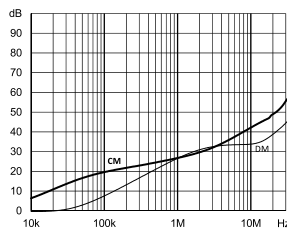

FN 9266 B Type 6 A

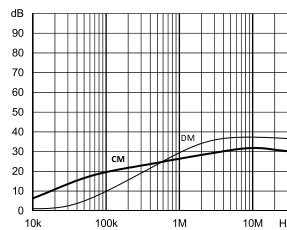

FN 9266 Standard Type 10 A

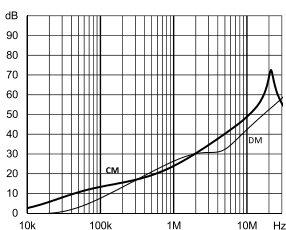

FN 9266 A Type 10 A

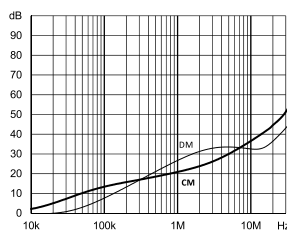

FN 9266 B Type 10 A

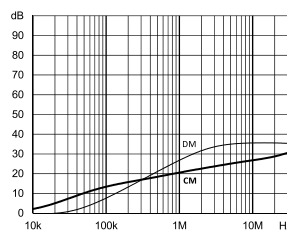

Mechanical data

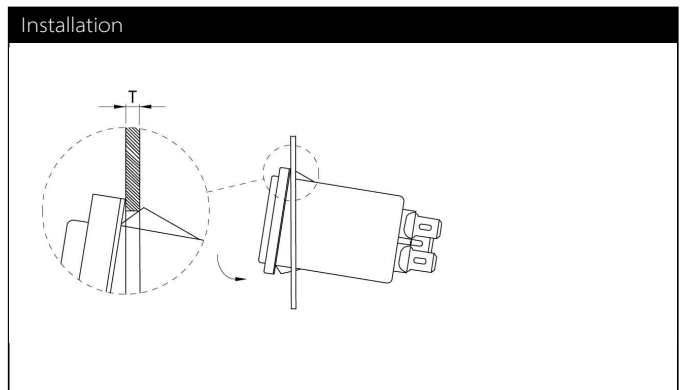
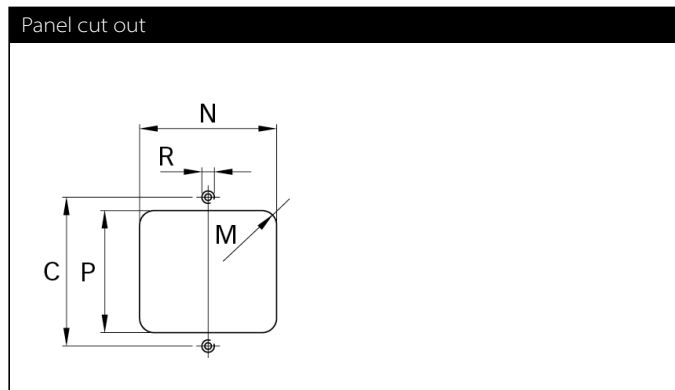
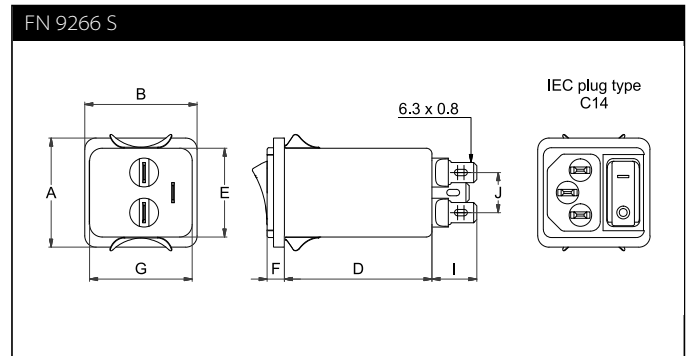
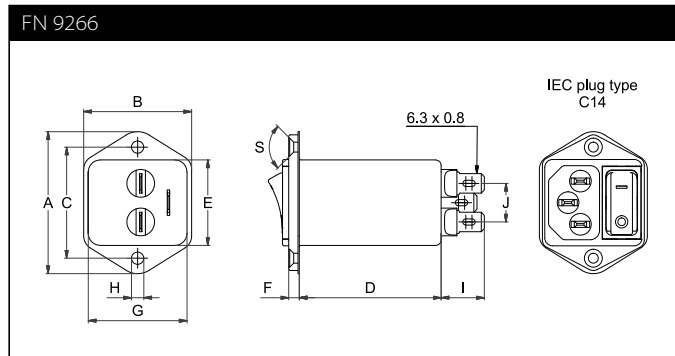

Dimensions

	FN 9266	FN 9266 S	Tolerances
A	46	34	±0.3
B	35	35	±0.3
C	36		±0.3
D	46	46	±0.3
E	27.8	27.8	+0.3/-0
F	5.5	5.5	±0.3
G	32	32	+0.3/-0
H	Ø3.2		±0.1
I	14	14	±0.5
J	12.5	12.5	±0.3
M	R ≤3.5	R ≤3.5	
N	33 +0.3/-0	33 +0.2/-0	
P	29 ±0.3	29.5 ±0.2	
R*	M3		
S	90°		
T**		0.6-1.5	
T**		1.6-2.5	
T**		2.6-3.5	

* Recommended torque for M3 (90° countersunk flat head) is 0.5 Nm

** For selecting the panel thickness, please refer to the filter selector table.

All dimensions in mm; 1 inch = 25.4 mm
Tolerances according to: ISO 2768-m/EN 22768-m

Please visit www.schaffner.com to find more details on filter connections.



Headquarters, global innovation and development

Switzerland

Schaffner Group

Industrie Nord
Nordstrasse 11e
4542 Luterbach
T +41 32 681 66 26
info@schaffner.com

To find your local partner within Schaffner's global network: www.schaffner.com

© 2018 Schaffner Group

The content of this document has been carefully checked and understood. However, neither Schaffner nor its subsidiaries assume any liability whatsoever for any errors or inaccuracies of this document and the consequences thereof. Published specifications are subject to change without notice. Product suitability for any area of application must ultimately be determined by the customer. In all cases, products must never be operated outside their published specifications. Schaffner does not guarantee the availability of all published products. This disclaimer shall be governed by substantive Swiss law and resulting disputes shall be settled by the courts at the place of business of Schaffner Holding AG. Latest publications and a complete disclaimer can be downloaded from the Schaffner website. All trademarks recognized.



Sales and application centers

China

Schaffner EMC Ltd. Shanghai

T20-3 C, No 565 Chuangye Road,
Pudong district
201201 Shanghai
T +86 21 3813 9500
cschina@schaffner.com
www.schaffner.com.cn

Finland

Schaffner Oy

Sauvonrinne 19 H
08500 Lohja
T +358 10 567 2855
finlandsales@schaffner.com

France

Schaffner EMC S.A.S.

16-20 Rue Louis Rameau
95875 Bezons
T +33 1 34 34 30 60
F +33 1 39 47 02 28
francesales@schaffner.com

Germany

Schaffner Deutschland GmbH

Schoemperlenstrasse 12B
76185 Karlsruhe
T +49 721 56910
F +49 721 569110
germanysales@schaffner.com

India

Schaffner India Pvt. Ltd

REGUS WORLD TRADE CENTRE
WTC, 22nd Floor Unit No 2238, Brigade
Gateway Campus, 26/1, Dr. Rajkumar Road
Malleshwaram (W)
560055 Bangalore
T +91 80 67935355
indiasales@schaffner.com

Italy

Schaffner EMC S.r.l.

Via Ticino, 30
20900 Monza (MB)
T +39 039 21 41 070
italysales@schaffner.com

Japan

Schaffner EMC K.K.

Taiju-Seimei Sangenjaya Bldg.
1-32-12, Kamiuma, Setagaya-ku
154-0011 Tokyo
T +81 3 5712 3650
F +81 3 5712 3651
japansales@schaffner.com
www.schaffner.jp

Singapore

Schaffner EMC Pte Ltd.

#05-09, Kg Ubi Ind. Estate
408705 Singapore
T +65 6377 3283
F +65 6377 3281
singaporesales@schaffner.com

Spain

Schaffner EMC España

Calle Caléndula 93, Miniparc III, Edificio E
El Soto de Moraleja, Alcobendas
28109 Madrid
T +34 917 912 900
F +34 917 912 901
spainsales@schaffner.com

Sweden

Schaffner EMC AB

Östermalmstorg 1
114 42 Stockholm
T +46 8 5050 2425
swedensales@schaffner.com
www.schaffner.com

Switzerland

Schaffner EMV AG

Industrie Nord
Nordstrasse 11e
4542 Luterbach
T +41 32 681 66 26
switzerlandsales@schaffner.com

Taiwan R.O.C.

Schaffner EMV Ltd.

20 Floor-2, No 97, Section 1, XinTai 5th Road
22175 XiZhi District New Taipei City 22175
T +886 2 2697 5500
F +886 2 2697 5533
taiwansales@schaffner.com
www.schaffner.com.tw

Thailand

Schaffner EMC Co. Ltd.

Northern Region Industrial Estate
67 Moo 4 Tambon Ban Klang
Amphur Muangng P.O. Box 14
51000 Lamphun
T +66 53 58 11 04
F +66 53 58 10 19
thailandsales@schaffner.com

United Kingdom

Schaffner Ltd.

1, Oakmede Place
Binfield
RG42 4JF Berkshire
T +44 118 9770070
F +44 118 9792969
uksales@schaffner.com

USA

Schaffner EMC Inc.

52 Mayfield Avenue
Edison, New Jersey
T +1 732 225 9533
F +1 732 225 4789
usasales@schaffner.com
www.schaffnerusa.com

Schaffner North America

6722 Thirlane Road
24019 Roanoke, Virginia
T +1 276 228 7943
F +1 276 228 7953

Schaffner North America

823 Fairview Road
24382 Wytheville, Virginia
T +1 276 228 7943
F +1 276 228 7258