

Ecosine max, 480 VAC 60 Hz Full Performance Passive Harmonic Filters

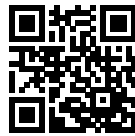

- Demonstrate best cost-performance ratio
- Achieve 5% THDi for diode rectifier without DC-link choke and thyristor rectifier
- Best-in-class partial load performance
- Most compact open panel design for cabinet integration
- Reliable and robust
- Plug and play, ready to use



Approvals & Compliances



Features and benefits

Schaffner ecosine harmonic filters represent an economical solution to the challenge of load-applied harmonics mitigation in three-phase power systems. With a plug-and-play approach and more compact dimensions than comparable products, they can be quickly installed and easily commissioned. They increase the reliability and service life of electric installations, help utilize electric system capacity better, and are the key to meet Power Quality standards such as IEEE 519. Ecosine filters reshape your distorted current back to the desired sinusoidal waveform. Schaffner ecosine filters can be applied to virtually any kind of power electronics with front-end six-pulse rectifiers, 3-phase diode or thyristor bridges, where harmonic current distortion needs to be reduced to defined limits.

Technical specifications

Nominal operating voltage	3 x 440 VAC to 480 VAC ±10%
Operating frequency	60 Hz ±1 Hz
Nominal motor drive input power rating	350 to 600 HP
Total harmonic current distortion THDi*	<5% @ rated power for drives without Ldc ~3.5% @ rated power for drives equipped with 4% Ldc
Efficiency	>99% for rated voltage and power
Overload capability	1.6x rated current for 1 minute, once per hour
SCCR**	100 kA (UL approved)
High potential test voltage	P -> E 2520 VAC (1s)
Overvoltage category	OV III (IEC 60664-1)
Earthing System	TN, TT, IT
Protection category	IP 00
Cooling	External cooling***
Ambient temperature range	-25°C to +40°C fully operational +40°C to +70°C derated operation**** -25°C to +85°C transport and storage
Design corresponding to	Filter: UL 61800-5-1, EN 61800-5-1 Chokes: EN 60076-6
Flammability corresponding to	UL 94 V-2
MTBF @ 40°C/480 V (Mil-HB-217F)	>200,000 hours

* System requirements: THDv <2%, line voltage unbalance <1%
Note: performance specifications in this brochure refer to six-pulse diode rectifiers. SCR rectifier front-ends will produce different results, dependent upon the firing angle of the thyristors.
** External UL-rated fuses required. Please consult the user manual.
*** Please check the inlet air flow required for cooling table further in this document and the user manual.
**** $I_{derated} = I_{nominal} \cdot \sqrt{\frac{(T_{max} - T_{amb})}{(T_{max} - T_{nominal})}} = I_{nom} \cdot \sqrt{\frac{(70^\circ\text{C} - T_{amb})}{30^\circ\text{C}}}$

Typical applications

- Equipment with front-end six-pulse rectifier
- Motor drives
- Factory automation equipment
- Water/wastewater treatment facilities
- Fan and pump applications
- HVAC installations
- Mission-critical processes
- DC fast chargers

Typical electrical schematic

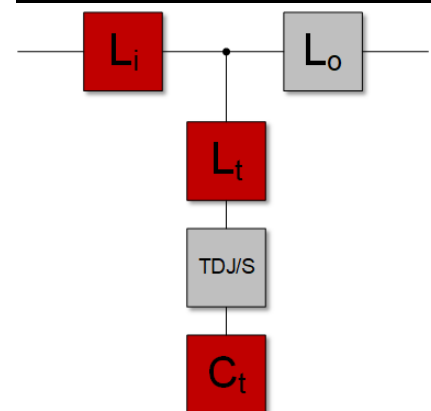

Filter selection table with circuit breaker module

Filter	Rated load power @ 480 V/60 Hz		Motor drive input current* [Arms]	Rated filter input current [Arms]	Typical losses @ 40°C [W]	Circuit breaker rated current [A]	Weight		Terminal	Frame size
	[kW]	[HP]					[kg]	[lbs]		
FN 3482-350-99-E0XXSXX	260	350	472	327	2832	200	245	540	Busbar	S10
FN 3482-400-99-E0XXSXX	300	400	537	375	3200	200	270	595	Busbar	S10
FN 3482-450-99-E0XXSXX	335	450	595	420	3451	250	295	650	Busbar	S10
FN 3482-500-99-E0XXSXX	370	500	656	469	3404	250	320	705	Busbar	S12
FN 3482-600-99-E0XXSXX	450	600	773	563	4173	300	385	849	Busbar	L10

* Motor drive input current without harmonic filter.

Filter selection table with trap disconnect jumper

Filter	Rated load power @ 480 V/ 60 Hz		Motor drive input current* [Arms]	Rated filter input current [Arms]	Typical power losses @ 40°C [W]	Weight		Terminal	Frame size
	[kW]	[HP]				[kg]	[lbs]		
FN 3482-350-99-E0XXJXX	260	350	472	327	2832	245	540	Busbar	S10
FN 3482-400-99-E0XXJXX	300	400	537	375	3200	270	595	Busbar	S10
FN 3482-450-99-E0XXJXX	335	450	595	420	3451	295	650	Busbar	S10
FN 3482-500-99-E0XXJXX	370	500	656	467	3404	320	705	Busbar	S12
FN 3482-600-99-E0XXJXX	450	600	773	563	4173	385	849	Busbar	L10

* Motor drive input current without harmonic filter.

Earth terminals

Earth (PE)	Screw thread	Screw torque value	
		[Nm]	[lbs.in]
S08-L12	M12	20-25	177-221

Frame size designation

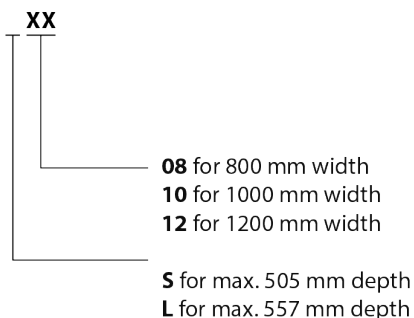

Product selector

FN 34nn-xxx-yyy-

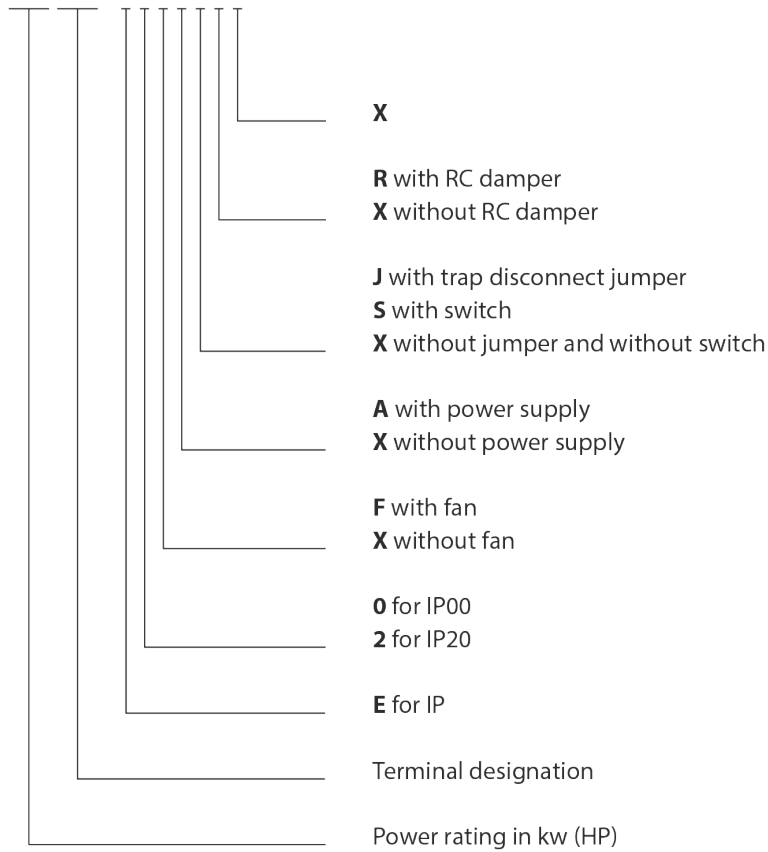

Filter configurations

E0XXSXX

- For rectifiers without DC-link choke
- Filters contain trap disconnect switch

E0XXJXX

- For rectifiers without DC-link choke
- Filters contain trap disconnect jumper

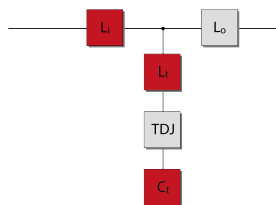
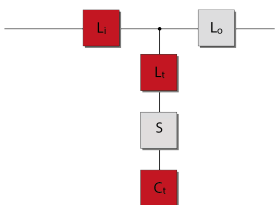

Mechanical data of IP 00 enclosure

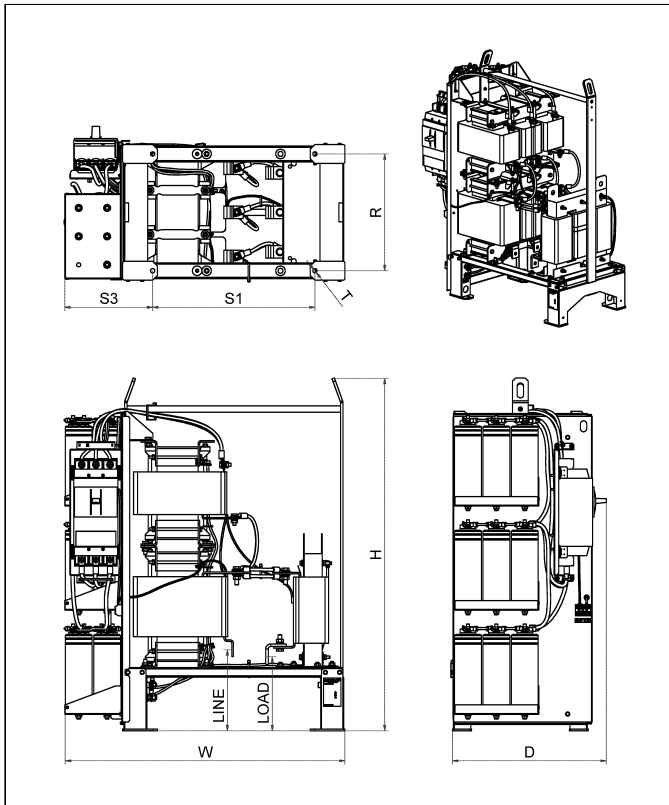

Dimensions in mm

Frame size*	W	D	H	R	S1	S2	S3	T	LINE	LOAD	Recommended cabinet size WxDxH
S08	max. 650	max. 505	1120	380	330	230	490	13.5	255 ± 10	470 ± 30	800x600x2000
S10	890	max. 505	1120	370	514	n/a	280	13.5	255 ± 10	240 ± 30	1000x600x2000
S12	1060	max. 505	1120	370	684	n/a	280	13.5	255 ± 10	230 ± 10	1200x600x2000
L08	max. 680	557	1320	458	320	225	485	13.5	290 ± 10	540 ± 30	800x600x2000
L10	890	max. 557	1320	455	504	n/a	285	13.5	290 ± 10	230 ± 10	1000x600x2000
L12	1060	max. 557	1320	455	674	n/a	285	13.5	290 ± 10	220 ± 10	1200x600x2000

* General tolerance: ISO 2768-v

Dimensions in inches

Frame size*	W	D	H	R	S1	S2	S3	T	LINE	LOAD	Recommended cabinet size WxDxH
S08	max. 25.6	max. 19.88	44.09	14.96	12.99	9.06	19.29	0.53	10.04 ± 0.039	18.5 ± 1.18	31.5x23.6x78.7
S10	35.04	max. 19.88	44.09	14.57	20.24	n/a	11.02	0.53	10.04 ± 0.039	9.45 ± 1.18	39.4x23.6x78.7
S12	41.73	max. 19.88	44.09	14.57	26.93	n/a	11.02	0.53	10.04 ± 0.039	9.06 ± 0.39	47.2x23.6x78.7
L08	max. 26.8	21.93	51.97	18.03	12.60	8.86	19.09	0.53	11.42 ± 0.039	21.26 ± 1.18	31.5x23.6x78.7
L10	35.04	max. 21.93	51.97	17.91	19.84	n/a	11.22	0.53	11.42 ± 0.039	9.06 ± 0.39	39.4x23.6x78.7
L12	41.73	max. 21.93	51.97	17.91	26.54	n/a	11.22	0.53	11.42 ± 0.039	8.66 ± 0.39	47.2x23.6x78.8

* General tolerance: ISO 2768-v

Inlet air flow required for cooling

Frame size	Min air volume*	
	[m ³ /h]	CFM [ft ³ /min]
S08, L08	1069	629
S10, L10	1069	629
S12, L12	1069	629

* Complete cooling requirement, including air inlet placement, must be followed. Please consult the user manual.



Headquarters, global innovation and development

Switzerland

Schaffner Group

Industrie Nord
Nordstrasse 11e
4542 Luterbach
T +41 32 681 66 26
info@schaffner.com



PQ sales

Switzerland

Schaffner Power Quality EMEA

Nordstrasse 11e
4542 Luterbach
T +41 32 681 66 80
pqsales@schaffner.com

China

Schaffner Power Quality China

T20-3 C, No 565 Chuangye Road
Pudong district
201201 Shanghai
T 021-38139500-2412
pqsales@schaffner.com

Singapore

Schaffner Power Quality APAC

#05-09, Kg Ubi Ind. Estate
Blk 3015A Ubi Road 1
408705 Singapore
T +65 6460 4166
pqsales@schaffner.com

www.schaffner.com

© 2020 Schaffner Group

The content of this document has been carefully checked and understood. However, neither Schaffner nor its subsidiaries assume any liability whatsoever for any errors or inaccuracies of this document and the consequences thereof. Published specifications are subject to change without notice. Product suitability for any area of application must ultimately be determined by the customer. In all cases, products must never be operated outside their published specifications. Schaffner does not guarantee the availability of all published products. This disclaimer shall be governed by substantive Swiss law and resulting disputes shall be settled by the courts at the place of business of Schaffner Holding AG. Latest publications and a complete disclaimer can be downloaded from the Schaffner website. All trademarks recognized.