

# High-current EMC/RFI Filter



- Off-the-shelf high power filter for rated currents up to 2500 A
- HV versions applicable for IT power networks
- Busbars for convenient and universal electrical connection
- Protective plastic covers optionally available for unsurpassed safety



### Performance indicators

Attenuation performance

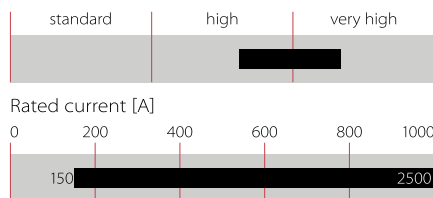

## Technical specifications

<b>Maximum continuous operating voltage</b>	3x 520/300 VAC (FN 3359) 3x 760/440 VAC (FN 3359 HV)
<b>Operating frequency</b>	DC to 60 Hz
<b>Rated currents</b>	150 to 2500 A @ 50°C
<b>High potential test voltage</b>	P → E 2750 VDC for 2 sec (FN 3359) P → P 2250 VDC for 2 sec (FN 3359) P → E 3200 VDC for 2 sec (FN 3359 HV) P → P 3270 VDC for 2 sec (FN 3359 HV)
<b>Protection category</b>	IP 00
<b>Overload capability</b>	4x rated current at switch on, 1.5x rated current for 1 minute, once per hour
<b>Temperature range (operation and storage)</b>	-25°C to +100°C (25/100/21)
<b>Flammability corresponding to</b>	UL 94 V-2 or better
<b>Design corresponding to</b>	UL 1283, CSA 22.2 No. 8 1986, IEC/EN 60939
<b>MTBF @ 45°C/480 V (Mil-HB-217F)</b>	130,000 hours

### Approvals & Compliances



UL: 600/400 VAC for 1600A and 2500A @ 40°C ambient temp.; ENEC up to 1600A: 690/400 VAC

### Features and benefits

- High-power filter for Class A compliance. With approval measurement also Class B compliance possible for some applications
- Extremely compact high-current filter solution with minimum space requirement
- FN 3359 HV versions are applicable for IT power networks
- Optionally available transparent protective covers for all filters up to 1000 A, to protect the installer, operator or inspector from undeliberate touching of life conductors. They can easily be retrofitted even if the filter is already installed and connected
- FN 3359 also improves conducted immunity of installations

### Typical applications

- High-power motor drives, inverters and converters
- Industrial three-phase systems
- Entire factories, plants and installations
- Large UPS
- Machinery
- Mining equipment
- Photovoltaic systems with galvanic isolation\*
- Wind turbines





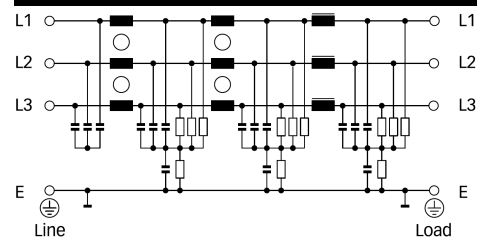

















\* For EMI solutions for PV system without galvanic isolation, please contact your local Schaffner partner.

### Typical electrical schematic



Note: HV versions without discharge resistor to ground.

### Filter selection table

Filter	Buy	Rated current	Typical drive	Leakage current**	Power loss	Input/Output	Weight	Protective
		@ 50°C (40°C)	power rating*	@ 520/760 VAC/50 Hz	@ 25°C/50 Hz	connections		covers***
		[A]	[kW]	[mA]	[W]	 	[kg]	Order code
FN3359-150-28		150 (164)	75	5.1	24	-28	5.8	801917
FN3359-180-28		180 (197)	90	5.1	34	-28	5.8	801917
FN3359-250-28		250 (250****)	132	5.1	49	-28	9.0	801918
FN3359-320-99		320 (350)	160	5.1	19	-99	10.5	801919
FN3359-400-99		400 (438)	220	5.1	29	-99	10.5	801919
FN3359-600-99		600 (657)	315	5.1	44	-99	11.0	801920
FN3359-800-99		800 (876)	400	5.3	39	-99	20.0	806276
FN3359-1000-99		1000 (1095)	560	5.3	60	-99	20.0	806276
FN3359-1600-99		1600 (1600)	900	5.1	131	-99	27.0	n.a.
FN3359-2500-99		2500 (2500)	1320	5.1	300	-99	69.0	n.a.
FN3359HV-150-28		150 (164)	110	7.5	24	-28	6.0	801917
FN3359HV-180-28		180 (197)	132	7.5	34	-28	6.0	801917
FN3359HV-250-28		250 (250)	200	7.5	49	-28	9.5	801918
FN3359HV-320-99		320 (350)	250	7.5	19	-99	10.5	801919
FN3359HV-400-99		400 (438)	315	7.5	29	-99	10.5	801919
FN3359HV-600-99		600 (657)	500	7.5	44	-99	11.0	801920
FN3359HV-800-99		800 (876)	630	7.5	39	-99	21.0	806276
FN3359HV-1000-99		1000 (1095)	710	7.5	60	-99	21.0	806276
FN3359HV-1600-99		1600 (1600)	1320	7.5	131	-99	27.0	n.a.
FN3359HV-2500-99		2500 (2500)	2000	7.7	300	-99	69.0	n.a.

\* Calculated at rated current, 480 VAC (FN 3359)/690 VAC (FN 3359 HV) and cos phi=0.8. The exact value depends upon the efficiency of the drive, the motor and the entire application.

\*\* Standardized calculated leakage current acc. IEC60939 under normal operating conditions (FN 3359 at 520 VAC and FN 3359 HV at 760 VAC).

\*\*\* Please contact your local Schaffner partner to order the optional protective covers with the order code in the table above (n.a.: not available)

\*\*\*\* For terminal type -28 the max. current is limited to 250A, therefore no uprating possible at lower temperatures.

### Distribution inventory

Up-to-date inventory levels for global distributors is available at

<https://products.schaffner.com/stock>

or via the QR code printed on the right side



### Typical filter attenuation

Per CISPR 17; A=50 Ω/50 Ω sym; B=50 Ω/50 Ω asym; C=0.1 Ω/100 Ω sym; D=100 Ω/0.1 Ω sym

150 to 180 A types

250 to 600 A types

800 and 1000 A types

1600 and 2500 A types

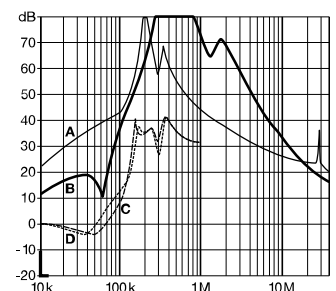
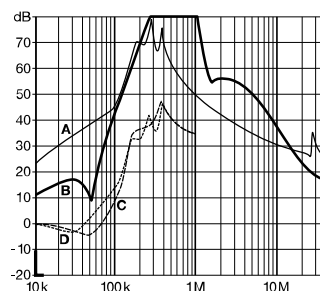
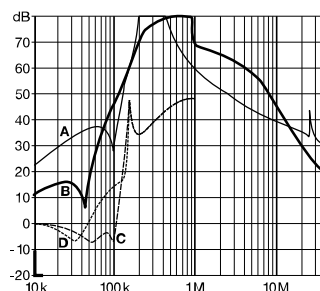
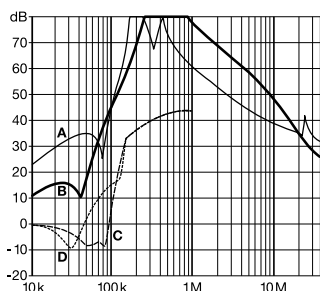

### Mechanical data

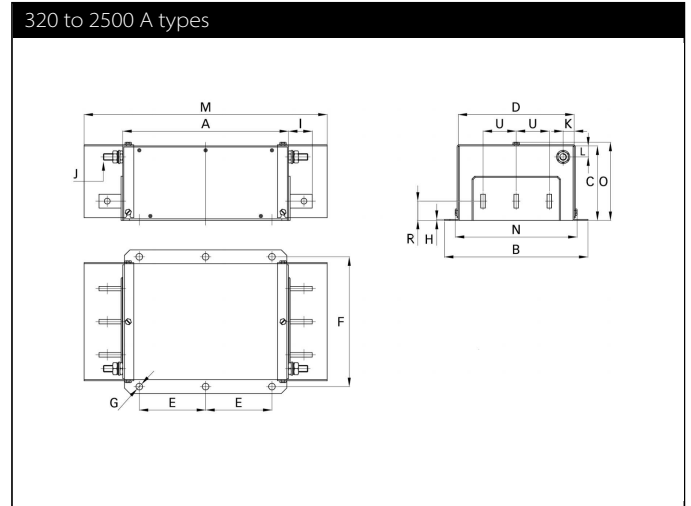
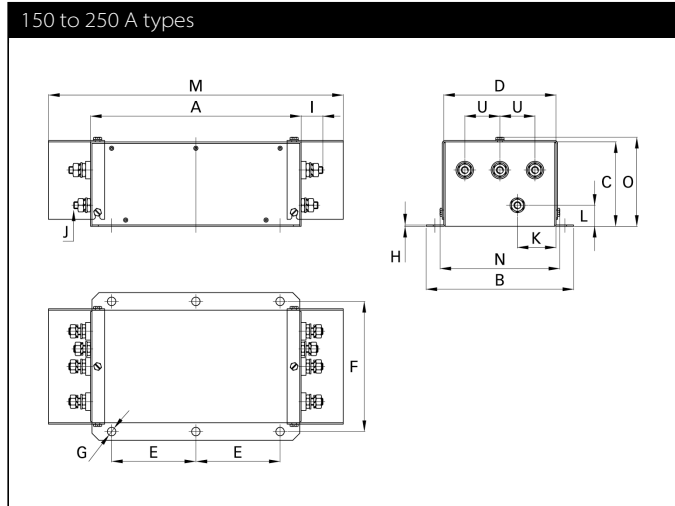

### Busbar connections

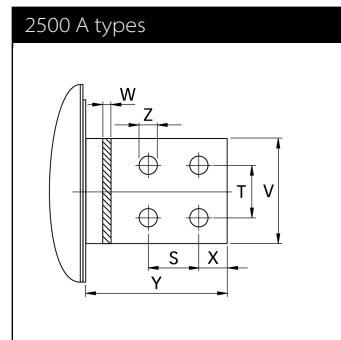
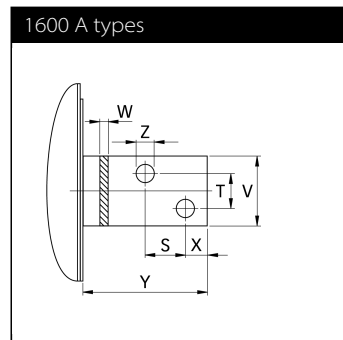
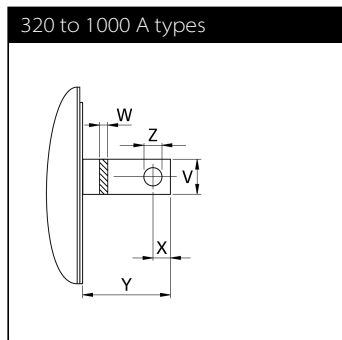

### Dimensions

	150 A	180 A	250 A	320 A	400 A	600 A	800 A	1000 A	1600 A	2500 A
<b>A</b>	300	300	300	300	300	300	350	350	400	450
<b>B</b>	210	210	230	260	260	260	280	280	300	370
<b>C</b>	120	120	125	115	115	135	170	170	160	220
<b>D</b>	160	160	180	210	210	210	230	230	250	300
<b>E</b>	120	120	120	120	120	120	145	145	170	200
<b>F</b>	185	185	205	235	235	235	255	255	275	330
<b>G</b>	Ø12	Ø12	Ø12	Ø12	Ø12	Ø12	Ø12	Ø12	Ø12	Ø14
<b>H</b>	2	2	2	2	2	2	3	3	3	3
<b>I</b>	33	33	33	43	43	43	53	53	93	110
<b>J</b>	M10	M10	M10	M12	M12	M12	M12	M12	M12	M12
<b>K</b>	55	55	62.5	20	20	20	25	25	25	25
<b>L</b>	30	30	35	20	20	20	25	25	25	25
<b>M</b>	420	420	420	440	440	440	510	510	n.a.	n.a.
<b>N</b>	171	171	191	221	221	221	241	241	n.a.	n.a.
<b>O</b>	127	127	132	122	122	142	177	177	n.a.	n.a.
<b>R</b>				37	37	37	68	68	68	85
<b>S</b>									26	35
<b>T</b>									26	35
<b>U</b>	50	50	55	60	60	60	60	60	60	100
<b>V</b>				25	25	25	40	40	60	80
<b>W</b>				6	6	8	8	8	10	15
<b>X</b>				15	15	15	20	20	17	20
<b>Y</b>				40	40	40	50	50	93	110
<b>Z</b>				Ø10.5	Ø10.5	Ø10.5	Ø14	Ø14	Ø14	Ø14

All dimensions in mm; 1 inch = 25.4 mm

Tolerances according: ISO 2768-m/EN 22768-m

(n.a.: not applicable)

Please visit [www.schaffner.com](http://www.schaffner.com) to find more details on filter connectors.

## Accessories

### Protective Cover for Busbar Filters

#### Construction schematic

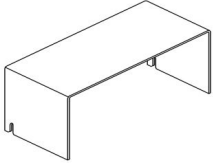

#### Installation example

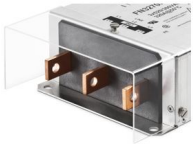

#### Applicable Busbar Filters

FN3359

FN3270



Transparent protective covers for FN3359 and FN3270 with busbars from 150 to 1000 A

Protection for the operator or inspector from accidental touching of live conductors.

Easily to be added after the filter has been installed and connected.

[Datasheet PDF >](#)

### Surge Protection Devices



SPD with a fail safe function to prevent short-circuit (separation of circuit and element is visually confirmable)

Compliance with IEC 61643-1 that meets the new JIS standards

Against indirect lightning surge for single phase / three phase power supplies Quick response for surge

Impulse current capacity 8/20 $\mu$ s-5,000A

Impulse test category: Class II (Type II)

Every pathway consists of same elements. Between line and line/between lines and ground can protect as the same level.

[Datasheet PDF >](#)



## Headquarters, global innovation and development

### Switzerland

#### Schaffner Group

Industrie Nord  
Nordstrasse 11e  
4542 Luterbach  
T +41 32 681 66 26  
[info@schaffner.com](mailto:info@schaffner.com)



## Sales and application centers

### China

#### Schaffner EMC Ltd. Shanghai

T20-3 C, No 565 Chuangye Road,  
Pudong district  
201201 Shanghai  
T +86 21 3813 9500  
[cschina@schaffner.com](mailto:cschina@schaffner.com)  
[www.schaffner.com.cn](http://www.schaffner.com.cn)

### Finland

#### Schaffner Oy

Sauvonrinne 19 H  
08500 Lohja  
T +358 50 468 7284  
[finlandsales@schaffner.com](mailto:finlandsales@schaffner.com)

### France

#### Schaffner EMC S.A.S.

16-20 Rue Louis Rameau  
95875 Bezons  
T +33 1 34 34 30 60  
F +33 1 39 47 02 28  
[francesales@schaffner.com](mailto:francesales@schaffner.com)

### Germany

#### Schaffner Deutschland GmbH

Schoemperlenstrasse 12B  
76185 Karlsruhe  
T +49 721 56910  
F +49 721 569110  
[germanysales@schaffner.com](mailto:germanysales@schaffner.com)

### India

#### Schaffner India Pvt. Ltd

REGUS WORLD TRADE CENTRE  
WTC, 22nd Floor Unit No 2238, Brigade  
Gateway Campus, 26/1, Dr. Rajkumar Road  
Malleshwaram (W)  
560055 Bangalore  
T +91 80 67935355  
[indiasales@schaffner.com](mailto:indiasales@schaffner.com)

### Italy

#### Schaffner EMC S.r.l.

Via Ticino, 30  
20900 Monza (MB)  
T +39 039 21 41 070  
[italysales@schaffner.com](mailto:italysales@schaffner.com)

### Japan

#### Schaffner EMC K.K.

Taiju-Seimei Sangenjaya Bldg.  
1-32-12, Kamiyama, Setagaya-ku  
154-0011 Tokyo  
T +81 3 5712 3650  
F +81 3 5712 3651  
[japansales@schaffner.com](mailto:japansales@schaffner.com)  
[www.schaffner.jp](http://www.schaffner.jp)

### Singapore

#### Schaffner EMC Pte Ltd.

#05-09, Kg Ubi Ind. Estate  
408705 Singapore  
T +65 6377 3283  
F +65 6377 3281  
[singaporesales@schaffner.com](mailto:singaporesales@schaffner.com)

### Spain

#### Schaffner EMC España

Calle Caléndula 93, Miniparc III, Edificio E  
El Soto de Moraleja, Alcobendas  
28109 Madrid  
T +34 917 912 900  
F +34 917 912 901  
[spainsales@schaffner.com](mailto:spainsales@schaffner.com)

### Sweden

#### Schaffner EMC AB

Östermalmstorg 1  
114 42 Stockholm  
T +46 8 5050 2425  
[swedensales@schaffner.com](mailto:swedensales@schaffner.com)  
[www.schaffner.com](http://www.schaffner.com)

### Switzerland

#### Schaffner EMV AG

Industrie Nord  
Nordstrasse 11e  
4542 Luterbach  
T +41 32 681 66 88  
T +41 32 681 66 26  
[switzerlandsales@schaffner.com](mailto:switzerlandsales@schaffner.com)

### Taiwan

#### Schaffner EMV Ltd.

20 Floor-2, No 97, Section 1, XinTai 5th Road  
22175 XiZhi District New Taipei City 22175  
T +886 2 2697 5500  
F +886 2 2697 5533  
[taiwansales@schaffner.com](mailto:taiwansales@schaffner.com)  
[www.schaffner.com.tw](http://www.schaffner.com.tw)

### Thailand

#### Schaffner EMC Co. Ltd.

Northern Region Industrial Estate  
67 Moo 4 Tambon Ban Klang  
Amphur Muangng P.O. Box 14  
51000 Lamphun  
T +66 53 58 11 04  
F +66 53 58 10 19  
[thailandsales@schaffner.com](mailto:thailandsales@schaffner.com)

### United Kingdom

#### Schaffner Ltd.

1, Oakmede Place  
Binfield  
RG42 4JF Berkshire  
T +44 118 9770070  
F +44 118 9792969  
[uksales@schaffner.com](mailto:uksales@schaffner.com)

### USA

#### Schaffner EMC Inc.

52 Mayfield Avenue  
Edison, New Jersey  
T +1 732 225 9533  
F +1 732 225 4789  
[usasales@schaffner.com](mailto:usasales@schaffner.com)  
[www.schaffnerusa.com](http://www.schaffnerusa.com)

To find your local partner within Schaffner's global network: [www.schaffner.com](http://www.schaffner.com)

© 2020 Schaffner Group

The content of this document has been carefully checked and understood. However, neither Schaffner nor its subsidiaries assume any liability whatsoever for any errors or inaccuracies of this document and the consequences thereof. Published specifications are subject to change without notice. Product suitability for any area of application must ultimately be determined by the customer. In all cases, products must never be operated outside their published specifications. Schaffner does not guarantee the availability of all published products. This disclaimer shall be governed by substantive Swiss law and resulting disputes shall be settled by the courts at the place of business of Schaffner Holding AG. Latest publications and a complete disclaimer can be downloaded from the Schaffner website. All trademarks recognized.