

Add-on Sine Wave Module for Common-mode Voltage Improvement



- Additional module for use with FN5420 or FN5020 sine wave filters
- Reduction of common-mode interferences on motor cables
- Improvement of EMC environment
- Elimination of motor bearing damages
- Possibility to use very long unshielded motor cables
- Improvement of system reliability



Performance indicators

Typical motor power [kW]

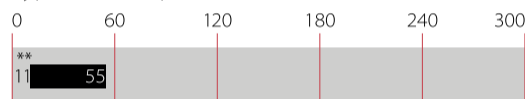

Rated current [A]

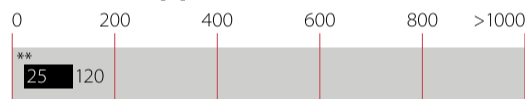

Technical Specifications

Maximum continuous operating voltage dc link voltage	3x 500/288 VAC
Motor frequency	0 to 600 Hz
Switching frequency	6 to 15 kHz
Rated currents	25 to 120 A @ 50°C
Motor cable length	1000 m max. (in combination with FN 5020 only)
High potential test voltage	P → E 2000 VAC for 2 sec P → P 1100 VDC for 2 sec
Protection category	IP 20
Overload capability	1.5x rated current for 1 minute, once per hour
Temperature range (operation and storage)	-25°C to +100°C (25/100/21)
Flammability corresponding to	UL 94 V-2 or better
Design corresponding to	UL 1283, CSA 22.2 No. 8 1986, IEC/EN 60939
MTBF @ 50°C/400 V (Mil-HB-217F)	>100,000 hours
Lifetime (calculated)	>10 years (25, 55 A) ~5 years (75, 120 A)

Approvals & Compliances

RoHS

Features and Benefits

- Add-on output filter module for the use with FN5420 or FN5020 sine wave output filters with corresponding current rating
- Elimination of premature motor failure caused by bearing damage
- Eliminates interference propagation towards components or conductors in the vicinity
- Restricts pulse currents to ground and hence limits leakage currents in the PE
- Allows the use of extremely long unshielded motor cables without causing radiation problems (EN 55014, MDS clamp)
- Reduces the required EMI suppression efforts on the line side
- Allows the use of lower rated drives with long motor cables due to lower losses in the IGBTs and in the motor cable
- Suitable for rotating fields up to 600 Hz

Typical Applications

- Motor drive applications with extremely long motor cables
- Motor drive applications with unshielded motor cables
- Motor drives and motors in high-speed applications
- Mission critical applications
- Applications with multiple parallel motors
- Retrofit of motor drives into existing installations with old wiring and motors

Important note

FN5030 are additional common-mode modules. They can NOT work alone! FN5030 have to be operated downstream of a regular (symmetrical) sine wave output filter. Possible combinations are FN5020/FN5030 for motor frequencies up to 600 Hz, or FN5420/FN5030 for max. 60 Hz. For additional information please consult the Schaffner application note „Sinus Plus – New Output Filter Concept for Power Drive Systems“

Filter Selection Table

Filter	Rated current @ 50°C	Typical motor power rating*	Typical power loss**	Output connections	Weight [kg]
	[A]	[kW]	[W]		
FN 5030-25-33	25	15	n.a.	-33	13
FN 5030-55-34	55	30	n.a.	-34	14
FN 5030-75-35	75	45	n.a.	-35	27
FN 5030-120-35	120	75	n.a.	-35	40

* General purpose four-pole (1500 r/min) AC induction motor rated 480 V/50 Hz.

** Exact value highly depends upon the motor cable type and length, switching frequency, motor frequency and further stray parameters within the system. Please contact your local Schaffner partner for individual application support.

Typical Block Schematic

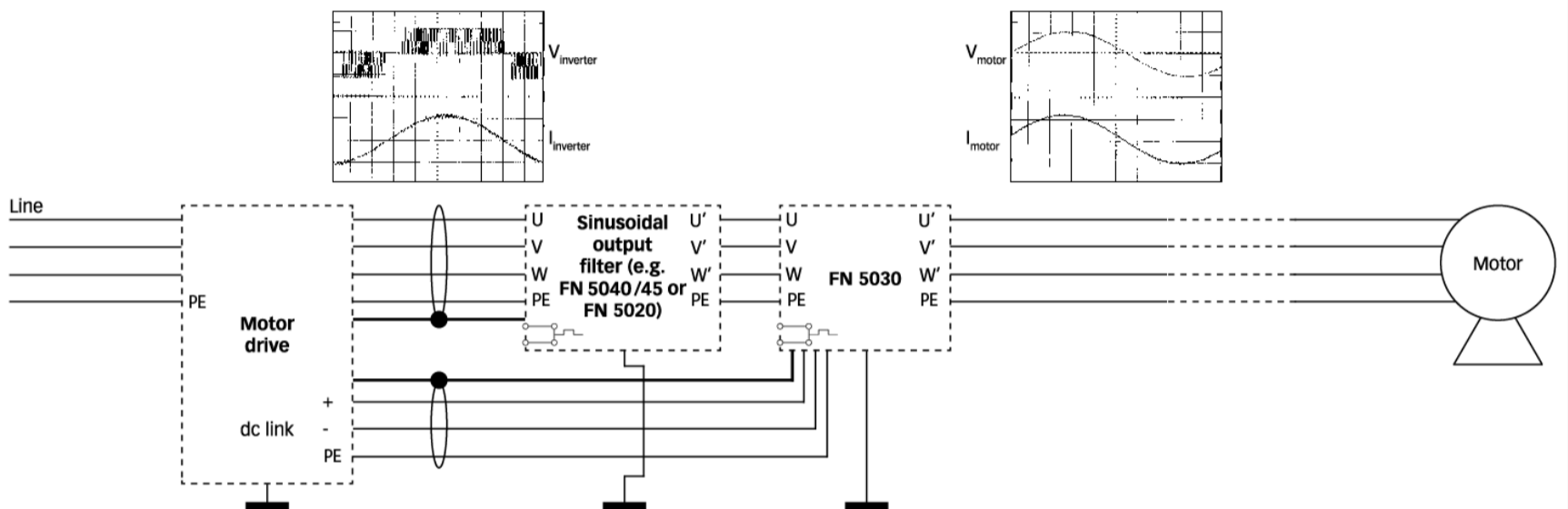

Temperature Monitoring Function

All filters of this range are equipped with a temperature monitoring function. The built-in temperature sensor opens a potential-free contact in the case of filter overtemperature (>120°C).

The maximum switching capability is 6 A/250 V. This function can be used, for example, in the input of a CNC controller or as the trip of a circuit breaker in order to interrupt the mains power supply. Connections are located next to the phase connectors (see mechanical data for details).

Forced Cooling

The 75 A and 120 A filters provide internal cooling fans which require external power supply (24 VDC/~4 W). Connections are located next to the connectors of the temperature sensor (see mechanical data for details).

Connection To The Dc Link

For best results, the connection to the dc link of the motor drive is required with this series of filters.

If only one connection to the dc link is brought out of the drive («+» or «-») then the dc link cable connections from the filter (identified by «DC+» and «DC-») must be connected together to the «+» or «-» motor drive connection.

The operation of the add-on sine wave output filter is not seriously affected as a result. The «+» and «-» connections on the motor drive must never be connected together. Otherwise a short-circuit will result.

The PWM switching frequency must lie within the range from 6 to 15 kHz in order to ensure satisfactory operation of the filter. A lower switching frequency or a pure square wave is unsuitable and will result in the motor drive switching off with the error message «overcurrent» or «short to earth».

Mechanical Data

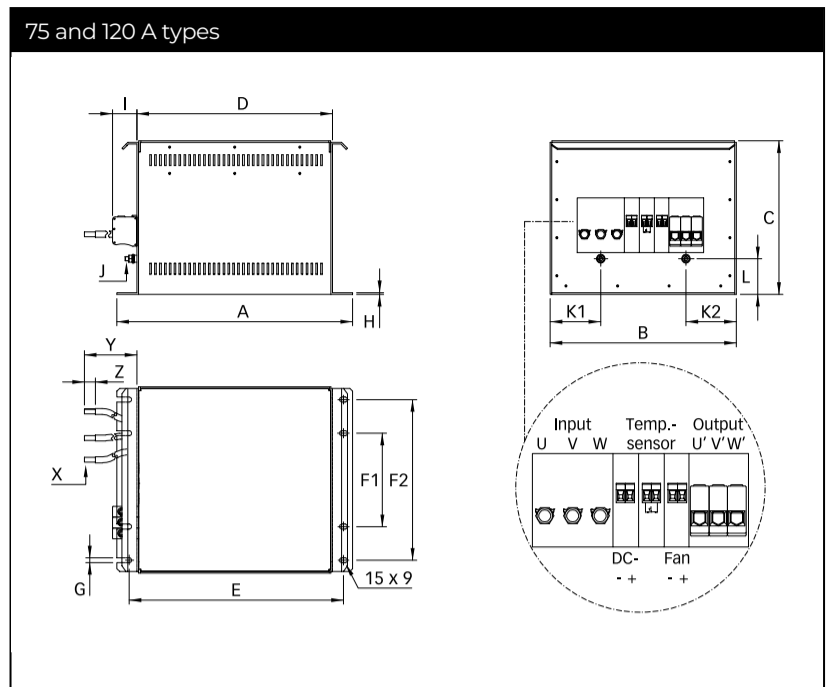
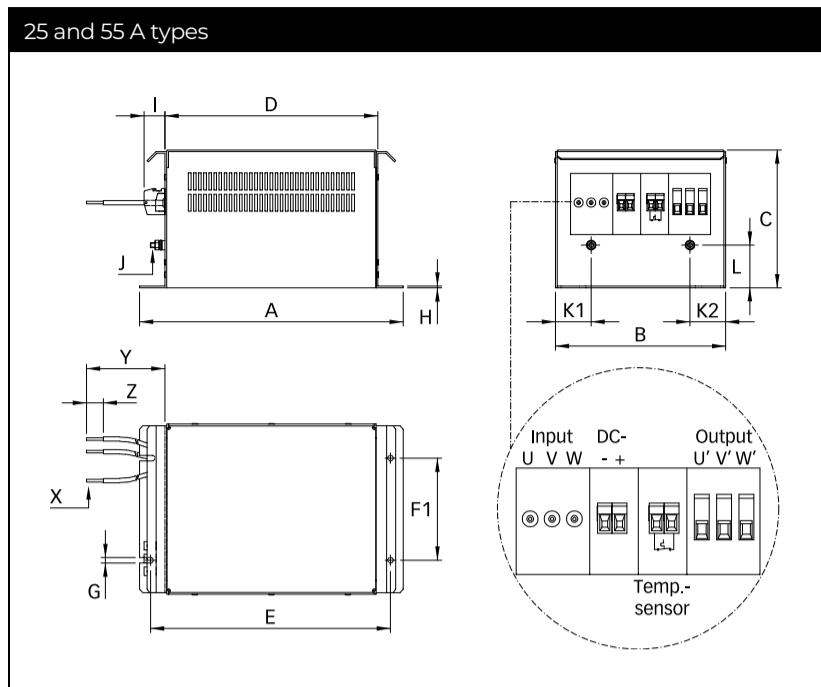





Dimensions

	25 A	55 A	75 A	120 A
A	310	354	434	434
B	200	250	343	343
C	162	200	283	283
D	246	300	360	360
E	280	324	395	395
F1	120	170	172	172
F2			296	296
G	6.5	9	9	9
H	2	3	3	3
I	25	39	45	45
J	M6	M6	M8	M8
K1	42	70	93	93
K2	42	55	93	93
L	50	66	66	66
X	AWG 10	AWG 6	25 mm ²	35 mm ²
Y	1000 +20/-0	1000 +20/-0	1000 +20/-0	1000 +20/-0
Z	20	20	20	20

All dimensions in mm; 1 inch = 25.4 mm
Tolerances according: ISO 2768-m / EN 22768-m

Filter Output Connector Cross Sections

	-29	-33	-34	-35
Solid wire	 6 mm ²	 16 mm ²	 35 mm ²	 50 mm ²
Flex wire	4 mm ²	10 mm ²	25 mm ²	50 mm ²
AWG type wire	AWG 10	AWG 6	AWG 2	AWG 1/0
Recommended torque	0.6-0.8 Nm	1.5-1.8 Nm	4.0-4.5 Nm	7-8 Nm

Please visit www.schaffner.com to find more details on filter connectors.

Headquarters, Global Innovation and Development

Switzerland

Schaffner Holding AG

Industrie Nord
Nordstrasse 11e
4542
Luterbach
+41 32 681 66 26
info@schaffner.com

Sales and Application Centers

Switzerland

Schaffner EMV AG

Industrie Nord
Nordstrasse 11e
4542
Luterbach
+41 32 681 66 26
switzerlandsales@schaffner.com

Singapore

Schaffner EMC Pte Ltd.

Blk 3015A Ubi Road 1, #05-09, Kampong Ubi
Industrial Estate
408705
Singapore
+65 63773283
singaporesales@schaffner.com

China

Schaffner EMC Ltd. Shanghai

T20-3 C, No 565 Chuangye Road, Pudong
district
201201
Shanghai
+86 2138139500
cschina@schaffner.com

To find your local partner within Schaffner's global network schaffner.com

© 2022 Schaffner Group

The content of this document has been carefully checked and understood. However, neither Schaffner nor its subsidiaries assume any liability whatsoever for any errors or inaccuracies of this document and the consequences thereof. Published specifications are subject to change without notice. Product suitability for any area of application must ultimately be determined by the customer. In all cases, products must never be operated outside their published specifications. Schaffner does not guarantee the availability of all published products. This disclaimer shall be governed by substantive Swiss law and resulting disputes shall be settled by the courts at the place of business of Schaffner Holding AG. Latest publications and a complete disclaimer can be downloaded from the Schaffner website. All trademarks recognized.