

Ultra-compact EMC/RFI Filter for Motor Drives Applications

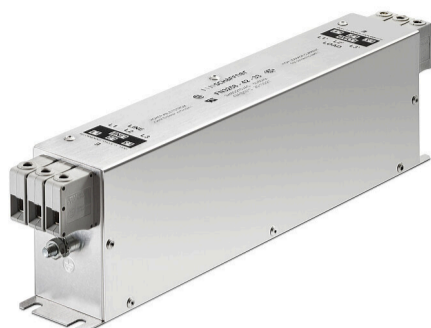

- New: solid safety connector blocks available for the whole range
- Exceptional attenuation performance from 150 kHz to 30 MHz
- Excellent saturation resistance up to 50 m cable length
- Most compact and slim filter design in its class



Performance indicators

Attenuation performance



Rated current [A]

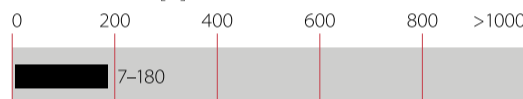

Technical Specifications

Maximum continuous operating voltage	3x520/300 VAC (FN 3258 H) 3x480/277 VAC (FN 3258)
Nominal operating voltage	480 VAC (FN 3258 H) 400 VAC (FN 3258)
Rated currents	7 to 180 A @ 50°C
Overload capability	4x rated current at switch on, 1.5x rated current for 1 minute, once per hour
Operating frequency	DC to 60 Hz
High potential test voltage	P → E 2650 / 2750 VDC for 2 sec (FN 3258 / FN 3258H) P → P 2100 / 2250 VDC for 2 sec (FN 3258 / FN 3258H)
Temperature range (operation and storage)	-25°C to +100°C (25/100/21)
Protection category	IP 20
Flammability corresponding to	UL 94 V-0
Design corresponding to	UL 1283, CSA 22.2 No. 8 1986, IEC/EN 60939
MTBF (Mil-HB-217F)	>300,000 h @ 50°C/480 V

Approvals & Compliances



Features and Benefits

- The extremely compact and slim filter design allows a trouble-free installation even where the available mounting space is minimal
- With new additional filter types providing safety terminal blocks, the most preferred connection style can be chosen fast and easy. This helps to stay in line with the electrical connection concept of a given application
- FN 3258 filters ensure compliance with Class A limits according to EN 55011 up to 50 m cable length and beyond. Further they can contribute significantly to meet conducted emission limits according to Class B
- Filter operation on the mains input side of consumers increases their reliability and conducted immunity significant
- Chokes with exceptional saturation resistance and excellent thermal behavior are a vital part of FN 3258 design. Thus, all filters retain the expected filter performance even in very noisy applications and under full load conditions







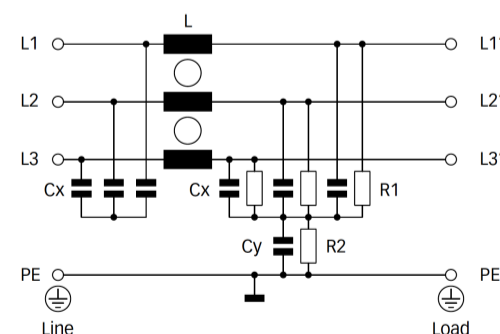





Typical Applications

- Three-phase variable speed motor drives, servo drives, inverters and converters
- Applications comprising energy conversion devices like machines or process automation equipment
- HVAC equipment, elevators, power supplies, UPS and further three-phase applications

Typical electrical schematic



Filter Selection Table

Filter	Buy	Rated current	Typical drive	Leakage current**	Power loss	Input/Output	Weight
		@ 50°C (40°C)	Power Rating*	@ 480/520 VAC/50 Hz	@ 25°C/50 Hz	Connections	
		[A]	[kW]	[mA]	[W]		[kg]
FN3258-7-44		7 (7.7)	4	4.3	3.8	-44	0.5
FN3258-16-44		16 (17.5)	7.5	4.3	6.1	-44	0.8
FN3258-30-33		30 (32.9)	15	4.3	11.8	-33	1.2
FN3258-42-33		42 (46.0)	22	4.3	15.7	-33	1.4
FN3258-55-34		55 (60.2)	30	4.3	25.9	-34	2.0
FN3258-75-34		75 (82.2)	37	4.3	32.2	-34	2.7
FN3258-100-35		100 (109.5)	55	4.3	34.5	-35	4.3
FN3258-130-35		130 (142.4)	75	4.3	43.1	-35	4.5
FN3258-180-40		180 (197.1)	90	4.3	58.3	-40	6.0
FN3258H-7-44		7 (7.7)	4	4.7	3.8	-44	0.5
FN3258H-16-44		16 (17.5)	7.5	4.7	6.1	-44	0.8
FN3258H-30-33		30 (32.9)	18.5	4.7	11.8	-33	1.2
FN3258H-42-33		42 (46.0)	22	4.7	15.7	-33	1.4
FN3258H-55-34		55 (60.2)	37	4.7	25.9	-34	2.0
FN3258H-75-34		75 (82.2)	45	4.7	32.2	-34	2.7
FN3258H-100-35		100 (109.5)	55	4.7	34.5	-35	4.3
FN3258H-130-35		130 (142.4)	75	4.7	43.1	-35	4.5
FN3258H-180-40		180 (197.1)	110	4.7	58.3	-40	6.0

* Calculated at rated current, 440 VAC (FN3258)/480 VAC (FN3258H) and $\cos \phi=0.8$. The exact value depends upon the efficiency of the drive, the motor and the entire application.

** Standardized calculated leakage current acc. IEC60939 under normal operating conditions (FN3258 at 480 VAC and FN3258H at 520 VAC).

Typical Filter Attenuation

Per CISPR 17; DM=50/50 sym; CM=50/50 asym

7 A type

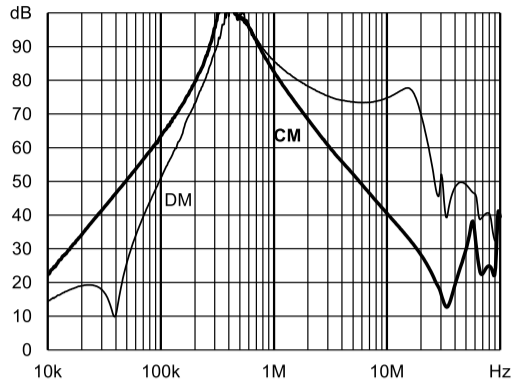

16 A type

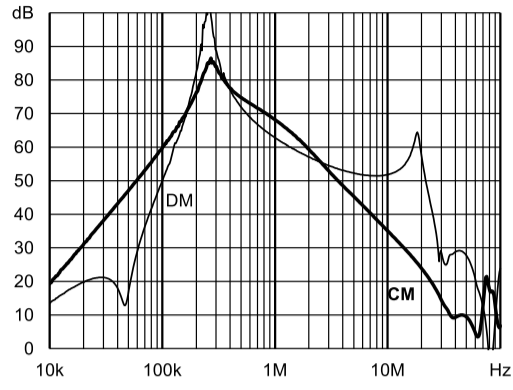

30 A type

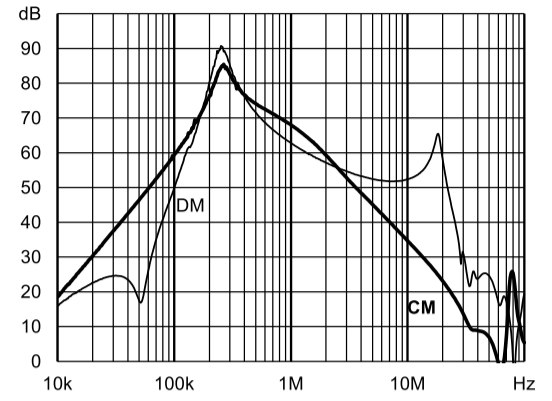

42 A type

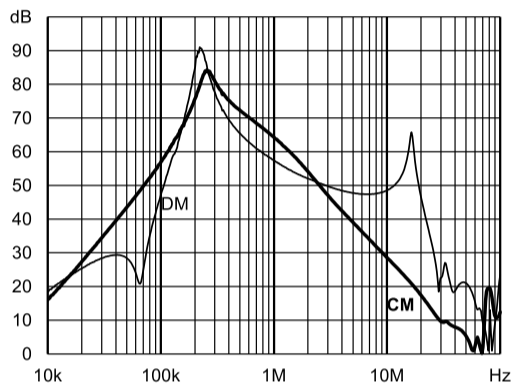

55 A type

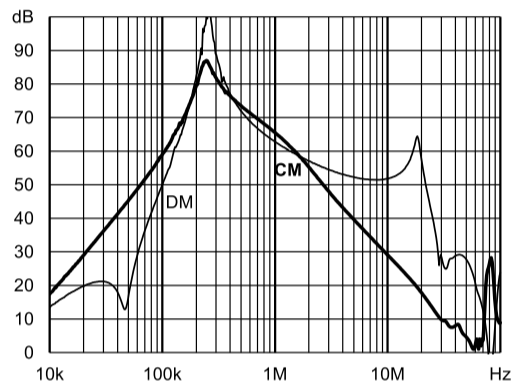

75 A type

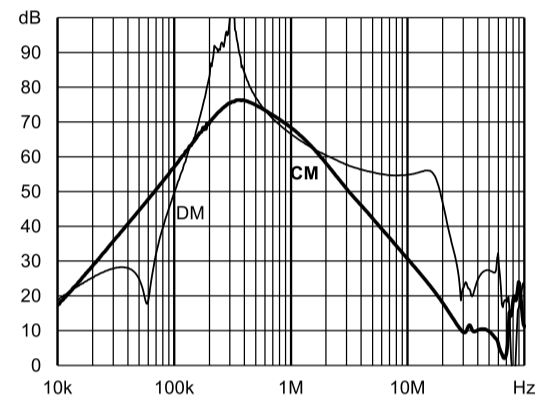

100 A type

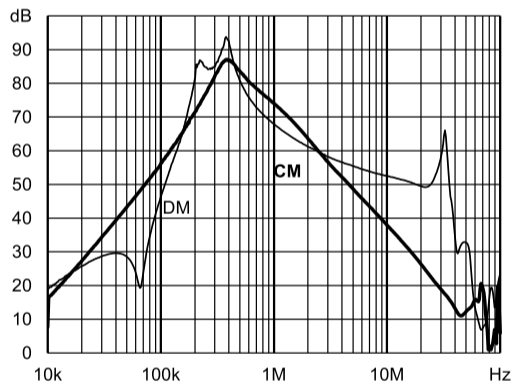

130 A type

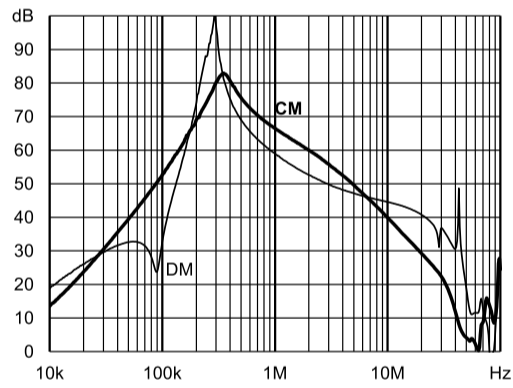

180 A type

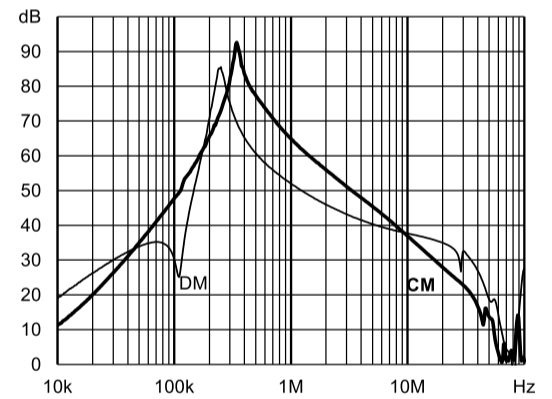

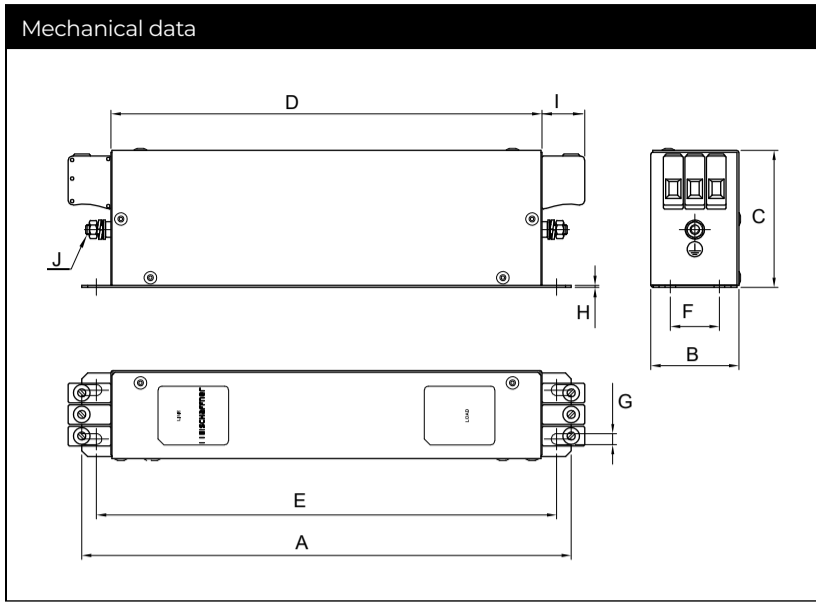

Note: in favour of a better readability, connectors and earth studs are not shown in the horizontal projection.

Dimensions

	7 A	16 A	30 A	42 A	55 A	75 A	100 A	130 A	180 A
A	190	250	270	310	250	270	270	270	380
B	40	45	50	50	85	80	90	90	120
C	70	70	85	85	90	135	150	150	170
D	160	220	240	280	220	240	240	240	350
E	180	235	255	295	235	255	255	255	365
F	20	25	30	30	60	60	65	65	102
G	4.5	5.4	5.4	5.4	5.4	6.5	6.5	6.5	6.5
H	1	1	1	1	1	1.5	1.5	1.5	1.5
I	22	22	25	25	39	39	45	45	51
J	M5	M5	M5	M6	M6	M6	M10	M10	M10
K	20	22.5	25	25	42.5	40	45	45	60
L2	29.5	29.5	39.5	37.5	26.5	70.5	64	64	47

All dimensions in mm; 1 inch = 25.4 mm

Tolerances according: ISO 2768-m/EN 22768-m

Filter Input/Output Connector Cross Sections

	-33	-34	-35	-40	-44
Solid wire	16 mm ²	35 mm ²	50 mm ²	95 mm ²	10 mm ²
Flex wire	10 mm ²	25 mm ²	50 mm ²	95 mm ²	6 mm ²
AWG type wire	AWG 6	AWG 2	AWG 1/0	AWG 4/0	AWG 8
Recommended torque	1.5-1.8 Nm	4.0-4.5 Nm	7-8 Nm	17-20 Nm	1.0-1.2 Nm

Please visit www.schaffner.com to find more details on filter connectors.

Headquarters, Global Innovation and Development

Switzerland

Schaffner Group
Industrie Nord
Nordstrasse 5
4542
Luterbach
+41 32 681 66 26
info@schaffner.com

Sales and Application Centers

Finland

Schaffner Oy
Lohjanharjuntie 1109
08500
Lohja
+ 358 50 468 72 84
finlandsales@schaffner.com

France

Schaffner EMC S.A.S.
16-20 Rue Louis Rameau
95875
Bezons
+33 1 34 34 30 60
francesales@schaffner.com

Germany

Schaffner Deutschland GmbH
Ohiostr. 8
76149
Karlsruhe
+49 721 56910
germanysales@schaffner.com

Italy

Schaffner EMC S.r.l.
Via Ticino, 30
20900
Monza (MB)
+39 335 120 44 32
italysales@schaffner.com

Japan

Schaffner EMC K.K.
ISM Sangenjaya 7F
1-32-12 Kamiyama Setagaya-ku
154-0011
Tokyo
+81 3 5712 3650
japansales@schaffner.com

Singapore

Schaffner EMC Pte Ltd.
Blk 3015A Ubi Road 1 #05-09 Kampong Ubi
Industrial Estate
408705
Singapore
+65 63773283
singaporesales@schaffner.com

Sweden

Schaffner EMC AB
Östermalmstrorg 1
114 42
Stockholm
+46 8 5050 2425
swedensales@schaffner.com

Switzerland

Schaffner EMV AG
Industrie Nord
Nordstrasse 5
4542
Luterbach
+41 32 681 66 26
switzerlandsales@schaffner.com

India

Schaffner India Pvt. Ltd
Regus World Trade Centre
WTC 22nd Floor Unit No 2238 Brigade
Gateway Campus 26/1 Dr. Rajkumar Road
Malleshwaram (W)
560055
Bangalore
+91 8067935355
indiasales@schaffner.com

United Kingdom

Schaffner Ltd.
Suite 1 Oakmede Place
Terrace Road
RG42 4JF
Binfield
+44 118 9770070
schaffner.uksales@te.com

United States

Schaffner EMC Inc.
52 Mayfield Avenue
Edison, New Jersey
+1 732 225 9533
usasales@schaffner.com

To find your local partner within Schaffner's global network schaffner.com

© 2025 Schaffner Group

The content of this document has been carefully checked and understood. However, neither Schaffner nor its subsidiaries assume any liability whatsoever for any errors or inaccuracies of this document and the consequences thereof. Published specifications are subject to change without notice. Product suitability for any area of application must ultimately be determined by the customer. In all cases, products must never be operated outside their published specifications. Schaffner does not guarantee the availability of all published products. This disclaimer shall be governed by substantive Swiss law and resulting disputes shall be settled by the courts at the place of business of Schaffner Holding AG. Latest publications and a complete disclaimer can be downloaded from the Schaffner website. All trademarks recognized.