

RT8522-63-0M5

SAP Code: 822802

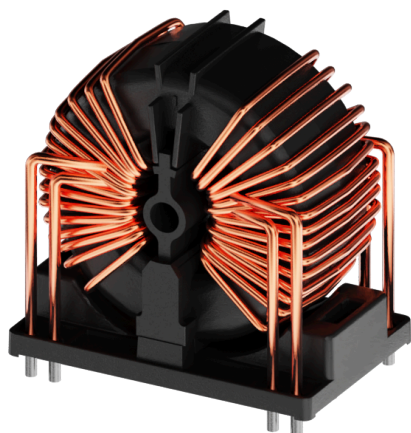

- PCB Common Mode Choke
- Vertical 63 A PCB two line Common Mode Choke with 0,5 mH Inductance
- General
- 2 Line

[Buy article now](#)



Family Technical Specifications

Rated currents	63
Rated inductance	0.3 to 6 mH (3-line) 0.5 to 10 mH (2-line)
Altitude	2000 m, current and voltage derating above
Vibration and shock	3M4 (according IEC 60721-3-3)
Flammability according to	UL 94 V0
MTBF	>2'000'000 h (MIL-HDBK-217)
Operating voltage	600 VAC (3-line) 300 VAC/425 VDC (2-line)
Operating frequency	DC to 400 Hz
Stray inductance	Max. 1% of rated inductance (@ 100 kHz 1 V, 0 A)
High potential test voltage	3 kV DC 3s (coil to coil) Repetition with max. 80% of the HV test voltage
Temperature range (operation and storage)	-40°C to +100°C (6 to 20 A) / -40°C to +125°C (25 to 63 A)
Climatic category	40/100/56 (acc. IEC 60068-1) (6 to 20 A) / 40/125/56 (acc. IEC 60068-1) (25 to 63 A)
Design corresponding to	UL/IEC 60938-1/-2 UL1446 (>20A)
Overvoltage category	III (acc. IEC 60664-1)
Creepage and clearance distances	Creepage & Clearance (2-line): ≥ 3.5 mm (Coil - Coil) / ≥ 3.0 mm (Coil-Core) Creepage & Clearance (3-line): ≥ 6.3 mm (Coil - Coil) / ≥ 5.5 mm (Coil-Core)
Pollution degree	PD2 (acc. IEC60664-1)

Approvals & Compliances



EIS applicable for currents > 20A

Features and Benefits

- Cost-effective PCB designs for up to 100 A with forced cooling *
- EIS (elektrical insulation system E332676) for currents > 20A acc. to UL 1446
- Compact size and light weight
- Low magnetic leakage flux
- Excellent winding insulation
- Standardized foot print
- Broad range of inductance ratings
- Custom-specific versions on request

Typical Applications

- AC and DC filtering for midsize power range drives, photovoltaic inverters, fast chargers, EV charging stations, UPS and switch mode power supplies
- Filter with low leakage current noise or improved immunity against grid disturbances
- Electronic devices, automation and (industrial) LED lighting
- Communication devices
- Medical and laboratory Equipment
- Converters

Typical electrical schematic

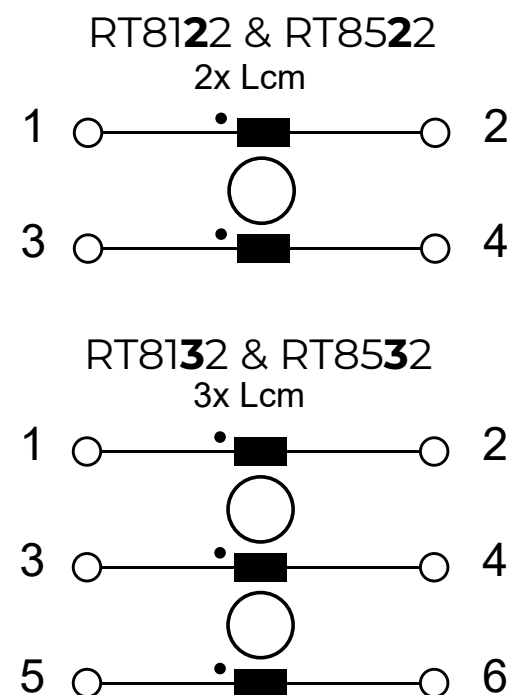

General Specification

Voltage AC	300 (Volt)
Voltage DC	425 (Volt)
Nominal Frequency	50 (Hertz)
Rated Current @ambient	63
Ambient temperature [°C]	60

Electric Specification

Input terminal	02 - PCB Pin
----------------	--------------

Attenuation Specification

Inductance L1	0.5 (Millihenry)
---------------	------------------

Attenuation graph

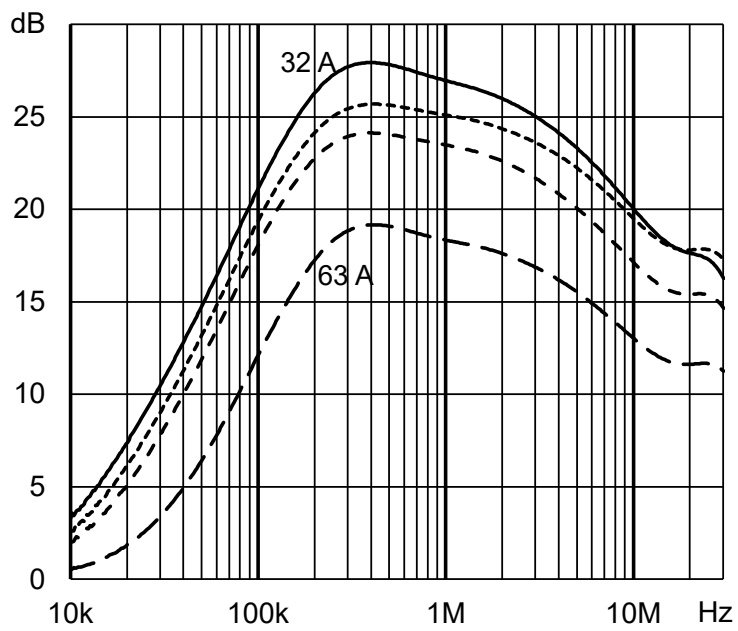

Mechanic Specification

Schaffner schemes

Mechanical Data Image

All dimensions in mm; 1 inch = 25.4 mm
Tolerances according: ISO 2768-m/EN 22768-m

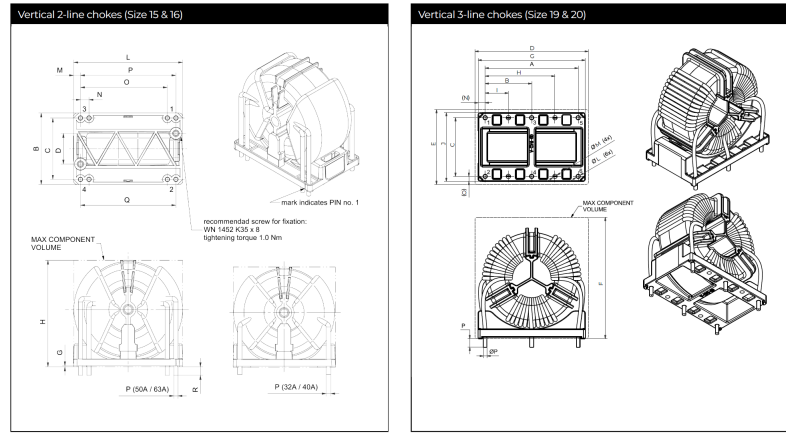

Dimensions

	H	G	B	C	D	L	M	N	O	P	Q	S	T	R	øP	øP	øP	øP	øP
															(25A)	(32A)	(40A)	(50A)	(63A)
Size 15 (RT8522-32-1M5, RT8522-40-1M2)	60	0.6	38	32	12	60	4		±0.4	±0.4	±0.4	±0.4	±0.2	±0.5	±0.1	±0.1	±0.1	±0.1	±0.1
Size 16 (RT8522-50-1M0, RT8522-63-0M5)	64	0.6	42	36	18	64	4	5	51	56	56			5				2.2	2.2
Size 19 (RT8532-25-1M5, RT8532-32-1M2)	63	0.6	38	32	12	60	4		26			52	46	5	2.4	2.4			
Size 20 (RT8532-40-0M7, RT8532-50-0M5, RT8532-63-0M3)	67	0.6	42	36	18	64	4	5	25.5	30.5	51	56	56	5			1.9	2.2	2.6

Dimensions