

RT8132-20-2M5

SAP Code: 816972



- PCB Common Mode Choke
- Horizontal 20 A PCB three line Common Mode Choke with 2,5 mH Inductance
- General
- 3 Line

[Buy article now](#)

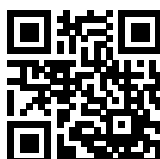

Family Technical Specifications

Rated currents	20
Rated inductance	0.3 to 6 mH (3-line) 0.5 to 10 mH (2-line)
Altitude	2000 m, current and voltage derating above
Vibration and shock	3M4 (according IEC 60721-3-3)
Flammability according to	UL 94 V0
MTBF	>2'000'000 h (MIL-HDBK-217)
Operating voltage	600 VAC (3-line) 300 VAC/425 VDC (2-line)
Operating frequency	DC to 400 Hz
Stray inductance	Max. 1% of rated inductance (@ 100 kHz 1 V, 0 A)
High potential test voltage	3 kV DC 3s (coil to coil) Repetition with max. 80% of the HV test voltage
Temperature range (operation and storage)	-40°C to +100°C (6 to 20 A) / -40°C to +125°C (25 to 63 A)
Climatic category	40/100/56 (acc. IEC 60068-1) (6 to 20 A) / 40/125/56 (acc. IEC 60068-1) (25 to 63 A)
Design corresponding to	UL/IEC 60938-1/-2 UL1446 (>20A)
Overvoltage category	III (acc. IEC 60664-1)
Creepage and clearance distances	Creepage & Clearance (2-line): ≥ 3.5 mm (Coil - Coil) / ≥ 3.0 mm (Coil-Core) Creepage & Clearance (3-line): ≥ 6.3 mm (Coil - Coil) / ≥ 5.5 mm (Coil-Core)
Pollution degree	PD2 (acc. IEC60664-1)

Approvals & Compliances



EIS applicable for currents > 20A

Features and Benefits

- Cost-effective PCB designs for up to 100 A with forced cooling *
- EIS (elektrical insulation system E332676) for currents > 20A acc. to UL 1446
- Compact size and light weight
- Low magnetic leakage flux
- Excellent winding insulation
- Standardized foot print
- Broad range of inductance ratings
- Custom-specific versions on request

Typical Applications

- AC and DC filtering for midsize power range drives, photovoltaic inverters, fast chargers, EV charging stations, UPS and switch mode power supplies
- Filter with low leakage current noise or improved immunity against grid disturbances
- Electronic devices, automation and (industrial) LED lighting
- Communication devices
- Medical and laboratory Equipment
- Converters

Typical electrical schematic

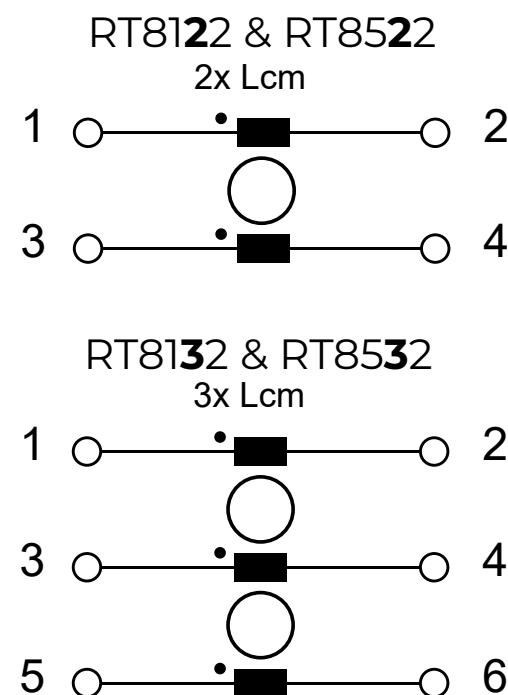

General Specification

Voltage AC	600 (Volt)
Nominal Frequency	50
Rated Current @ambient	20
Ambient temperature [°C]	60

Electric Specification

Input terminal	02 - PCB Pin
----------------	--------------

Attenuation Specification

Inductance L1	2.5 (Millihenry)
---------------	------------------

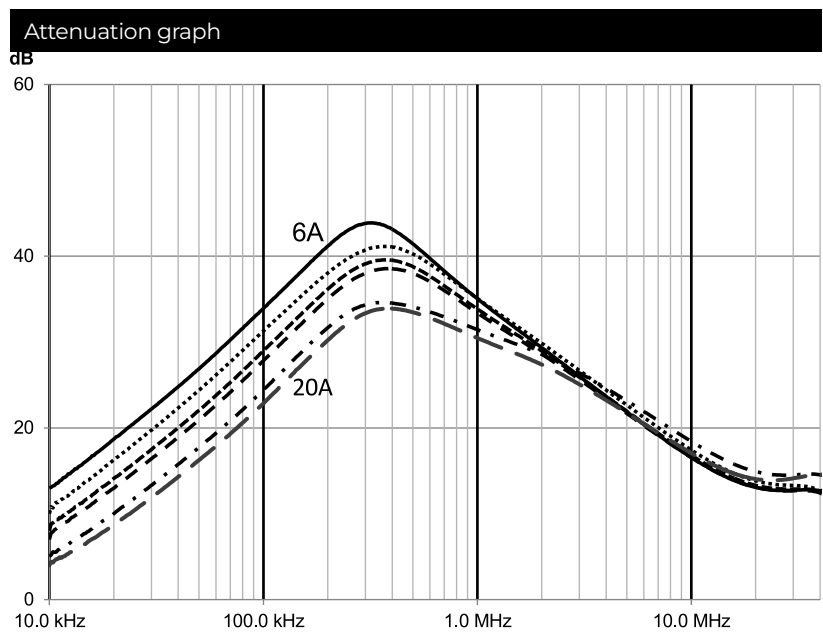

Mechanic Specification

Schaffner schemes

Mechanical Data Image

All dimensions in mm; 1 inch = 25.4 mm
Tolerances according: ISO 2768-m/EN 22768-m

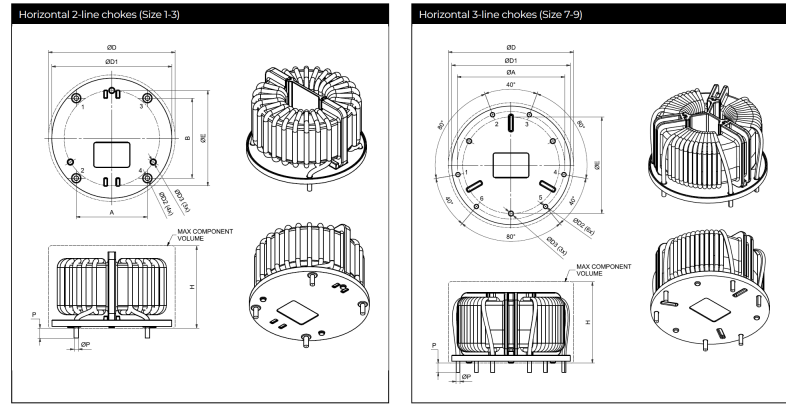

Dimensions

	A	B	ØD	H	ØD1	ØD2	ØD3	ØE
	(±0.5)	(±0.5)	(max)	(max)	(±0.5)			
Size1 (RT8122-6-10M0, RT8122-8-8M0, RT8122-10-6M0)	21	25	45	34	42	1.5	2.5	36
Size2 (RT8122-12-5M0, RT8122-16-4M0)	26	30	51	33	48	1.9	2.5	40
Size3 (RT8122-20-3M0)	32	36	57	37	54	2.1	2.5	43
Size 7 (RT8132-6-6M0, RT8132-8-4M8)	38	-	46	34	43	1.4	2.5	35
Size 8 (RT8132-10-4M0, RT8132-12-3M6)	44	-	51	33	48	1.7	2.5	40
Size 9 (RT8132-16-3M0, RT8132-20-2M5)	49	-	57	37	54	2.3	2.5	44

Dimensions