

RT8122-63-0M5

SAP Code: 822793

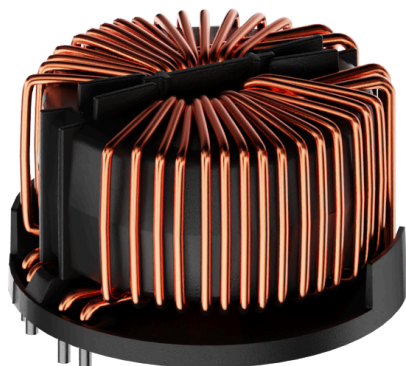

- PCB Common Mode Choke
- Horizontal 63 A PCB two line Common Mode Choke with 0,5 mH Inductance
- General
- 2 Line

[Buy article now](#)

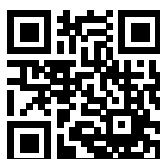

Family Technical Specifications

Rated currents	63
Rated inductance	0.3 to 6 mH (3-line) 0.5 to 10 mH (2-line)
Altitude	2000 m, current and voltage derating above
Vibration and shock	3M4 (according IEC 60721-3-3)
Flammability according to	UL 94 V0
MTBF	>2'000'000 h (MIL-HDBK-217)
Operating voltage	600 VAC (3-line) 300 VAC/425 VDC (2-line)
Operating frequency	DC to 400 Hz
Stray inductance	Max. 1% of rated inductance (@ 100 kHz 1 V, 0 A)
High potential test voltage	3 kV DC 3s (coil to coil) Repetition with max. 80% of the HV test voltage
Temperature range (operation and storage)	-40°C to +100°C (6 to 20 A) / -40°C to +125°C (25 to 63 A)
Climatic category	40/100/56 (acc. IEC 60068-1) (6 to 20 A) / 40/125/56 (acc. IEC 60068-1) (25 to 63 A)
Design corresponding to	UL/IEC 60938-1/-2 UL1446 (>20A)
Overvoltage category	III (acc. IEC 60664-1)
Creepage and clearance distances	Creepage & Clearance (2-line): ≥ 3.5 mm (Coil - Coil) / ≥ 3.0 mm (Coil-Core) Creepage & Clearance (3-line): ≥ 6.3 mm (Coil - Coil) / ≥ 5.5 mm (Coil-Core)
Pollution degree	PD2 (acc. IEC60664-1)

Approvals & Compliances

RoHS



EIS applicable for currents > 20A

Features and Benefits

- Cost-effective PCB designs for up to 100 A with forced cooling *
- EIS (elektrical insulation system E332676) for currents > 20A acc. to UL 1446
- Compact size and light weight
- Low magnetic leakage flux
- Excellent winding insulation
- Standardized foot print
- Broad range of inductance ratings
- Custom-specific versions on request

Typical Applications

- AC and DC filtering for midsize power range drives, photovoltaic inverters, fast chargers, EV charging stations, UPS and switch mode power supplies
- Filter with low leakage current noise or improved immunity against grid disturbances
- Electronic devices, automation and (industrial) LED lighting
- Communication devices
- Medical and laboratory Equipment
- Converters

Typical electrical schematic

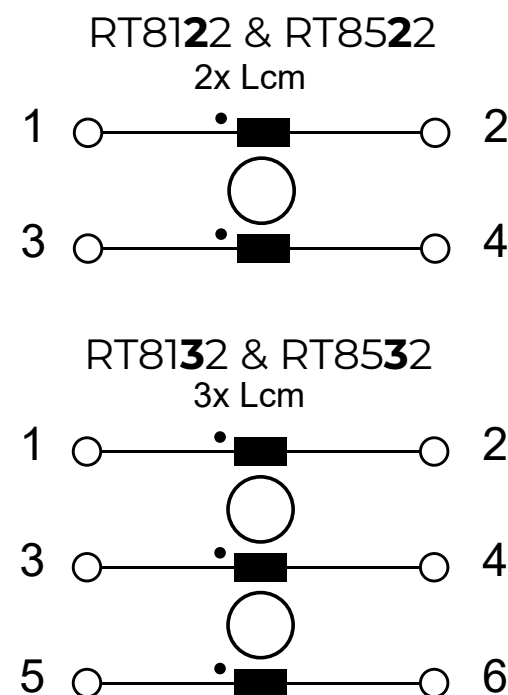

General Specification

Voltage AC	300 (Volt)
Voltage DC	425 (Volt)
Nominal Frequency	50 (Hertz)
Rated Current @ambient	63
Ambient temperature [°C]	60

Electric Specification

Input terminal	02 - PCB Pin
----------------	--------------

Attenuation Specification

Inductance L1	0.5 (Millihenry)
---------------	------------------

Attenuation graph

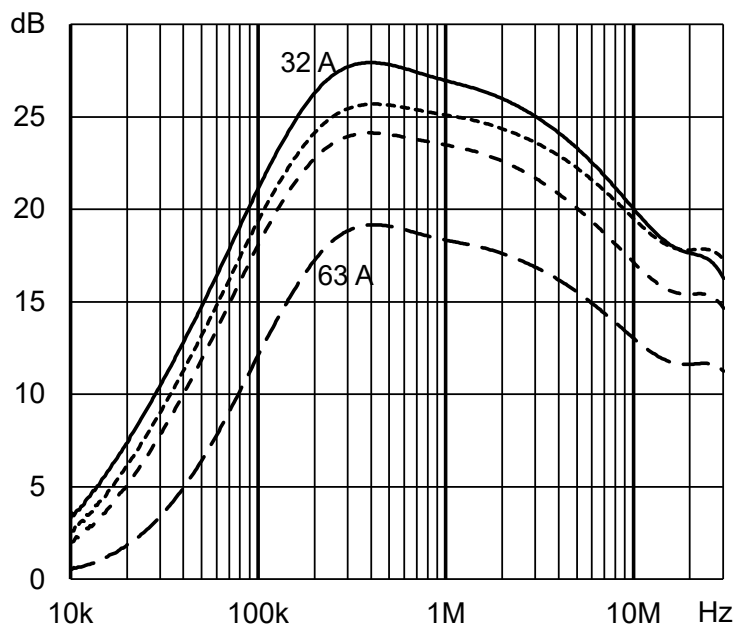

Mechanic Specification

Schaffner schemes

Mechanical Data Image

All dimensions in mm; 1 inch = 25.4 mm
Tolerances according: ISO 2768-m/EN 22768-m

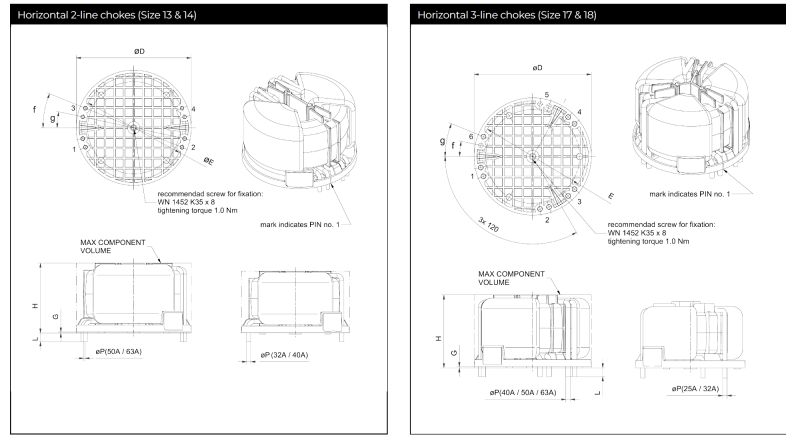

Dimensions

	eD	H	G	eE	f	g	L	ΦP (25A)	ΦP (32A)	ΦP (40A)	ΦP (50A)	ΦP (63A)
	±0.2	(max)	±0.1	±0.2	±10°	±10°	±0.5	±0.1	±0.1	±0.1	±0.1	±0.1
Size 13 (RT8122-32-1M5, RT8122-40-1M2)	62	37	0.6	55.4	150°	5	5	2.4	2.8	2.2	2.2	
Size 14 (RT8122-50-1M0, RT8122-63-0M5)	66	41	0.6	59.8	120°	220°	5					
Size 17 (RT8132-25-1M5, RT8132-32-1M2)	62	38	0.6	55.4	150°	5	2.4	2.4				
Size 18 (RT8132-40-0M7, RT8132-40-0M5, RT8132-63-0M3)	66	42	0.6	59.8	120°	220°	5		1.9	2.2	2.6	

Dimensions