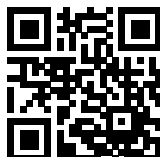

FN3032-10-61-C12-R6

SAP Code: 823389

- Chassis mount
- 10 A EMC filter with low leakage current for Japanese market (Nano crystalline version)
- 3 Phases

[Buy article now](#)

Family Technical Specifications

Operating voltage	530 / 305 VAC
Operating frequency	0 to 60 Hz
High potential test voltage	2.28 kV DC 60s, phase to phase 2.5 kV AC 60s, phase to protected earth Repetition with max. 80% of the HV test voltage
Temperature range (operation and storage)	-40°C to +100°C
Climatic category	40/100/21 (acc. IEC 60068-1)
Design corresponding to	UL/IEC 60939-3 CSA C22.2 No. 8-13
Overvoltage category	III (acc. IEC 60664-1)
Rated currents	10
Vibration and shock	According IEC60721-3-3, Level 3M4 Vibration: 10 to 55Hz, 2G, 3min, 1h each direction Shock: 20G, 11ms once each axis
Altitude	2000 m, current and voltage derating above
Protection category	IP 00 (acc. IEC 60529-1)
Flammability according to	UL 94 V0
Pollution degree	PD2 (acc. IEC60664-1)
Overload capability	1.5 x rated current for 1 minute once per hour
Surge withstand	2 kV, phase to phase (acc. to IEC 61000-4-5) 4 kV, phase to protected earth (acc. to IEC 61000-4-5)
MTBF	> 300'000 h
Operating voltage	530 / 305 VAC
Operating frequency	DC to 60 Hz
Rated currents	10
Vibration and shock	3M4 (acc. to IEC60721-3-3) Vibration: 10 to 55Hz, 2G, 3min, 1h each direction Shock: 20G, 11ms once each axis
Flammability according to	UL 94 V0
Overload capability	1.5 x rated current for 1 minute once per hour
Surge withstand	2 kV, phase to phase (acc. to IEC 61000-4-5) 4 kV, phase to protected earth (acc. to IEC 61000-4-5)
MTBF	> 300'000 h
High potential test voltage	2.28 kV DC 2s, phase to phase 2.5 kV AC 60s, phase to protected earth Repetition with max. 80% of the HV test voltage
Temperature range (operation and storage)	-40°C to +100°C (with derating >50°C)
Climatic category	40/100/21 (acc. IEC 60068-1)
Design corresponding to	UL/IEC 60939-3 CSA C22.2 No. 8-13
Overvoltage category	III (acc. IEC 60664-1)
Altitude	2000 m, current and voltage derating above
Protection category	IP 00 (acc. IEC 60529-1)
Pollution degree	PD2 (acc. IEC60664-1)

Approvals & Compliances



Features and Benefits

- A plastic housing combined with a metal ground plate achieve the lowest possible product weight without compromising EMC behaviour
- The embedded terminals from Schaffner guarantee user-friendly handling and reliable, long-lasting electrical connection
- fixed, hinged terminal covers contribute to overall safety by providing protection against unintended contact with live conductors. They are included in the standard scope of delivery without any extra cost
- Very low leakage current values make the filters suitable for grids with very tough requirements or sensitive GFCIs, and for applications which set value on safety and reliability
- FN3030 feature an ecologically conscious construction without the use of potting compound or banned substances (RoHS). Used raw materials can be easily separated at the end of the product life time for proper and environmentally safe disposal

Typical Applications

- Electrical and electronic equipment
- Test and measurement devices
- Medical devices & Industrial automation
- Small machines

Typical electrical schematic

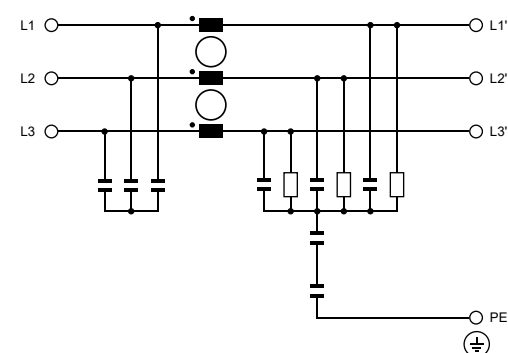

General Specification

Voltage AC	530 (Volt)
Nominal Frequency	60
Rated Current @ambient	10
Ambient temperature [°C]	50

Electric Specification

Leakage current (IEC60939) [mA]	0.3
Leakage current (Schaffner) [mA]	0.3
Input terminal	61 - M4 screw terminal block
Output terminal	61 - M4 screw terminal block

Attenuation Specification

CM attenuation @ 150kHz [dB]	37 (Decibels)
DM attenuation @ 150kHz [dB]	47 (Decibels)

Mechanic Specification

Length [mm]	128
Width [mm]	63
Height [mm]	50
Volume [cm ³]	484.2864 (Cubic Centimeter)
NetWeight [g]	500 (Gram)

Schaffner schemes

Dimensions