

FN2500-20-103-C13

SAP Code: 821790

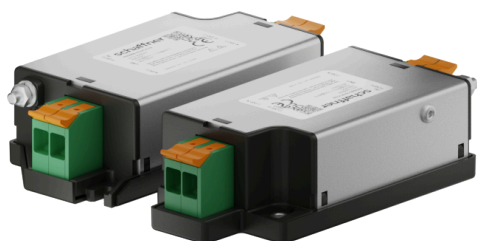

- Chassis mount
- 20 A EMC filter with push-in terminals
- 1 Phase

[Buy article now](#)

Family Technical Specifications

Rated operating voltage	277 VAC / 400 VDC (CQC: 250 VAC / 250 VDC)
Operating frequency	DC to 60 Hz
Protection category	IP00 / IP20 for -103 terminals
Pollution degree	2 acc. IEC 60664-1
Vibration and shock	3M12 acc. IEC 60721-3-3
Overtoltage category	II acc. IEC 60664-1
Temperature range (operation and storage)	FN2500: -40°C to +100°C (with derating >50°C) FN2520: -40°C to +85°C (with derating >50°C)
Cooling	Natural cooling AN
Climatic category	FN2500: 40/100/21 acc. IEC60068-1 FN2520: 40/085/21 acc. IEC60068-1 FN2520: 40/085/21 acc. IEC60068-1
Flammability corresponding to	Plastic material: UL 94 V0 Laces for -07 version: UL 94 VW1
Rated currents	20
Surge withstand	2 kV Ph-Ph / 4 kV Ph-PE (Level 4)
High potential test voltage	P(DC+) -> N(DC-) 1500 VDC for 2 sec* P(DC+)/N(DC-) -> PE 2500 VDC for 2 sec*
Overload capability	1.5 x rated current for 1 minute once per hour
Altitude	Derating above 2000 m
Certified to	UL/IEC 60939-3, CSA 22.2 No. 8-13, GB/T 15287
MTBF	> 300,000 h

* High potential test voltage: Repetition with max. 80% of specified values

Approvals & Compliances



Certifications FN2520 pending

Features and Benefits

- FN2500 / FN2520 series fits perfectly within 1HU height for rack mount
- The filters are built to perform perfectly in datacenter and audio video equipment
- The shape allows convenient and space-saving installation
- Fulfills the requirements in IEC/EN 62040-1 - Uninterruptible power systems (UPS)
- Fulfills the requirements in IEC 62368-1 - Audio/Video, Information and Communication Technology Equipment
- Fulfills the requirements in IEC/EN 60335-1 - Household and similar appliances

Typical Applications

- Datacenter (at 400 VDC)
- Building technology with DC power distribution
- Robotics, collaborative robots, autonomous machines
- Audio and video equipment
- UPS - Uninterruptible power supplies

Typical electrical schematic

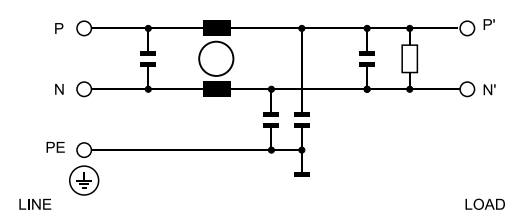

General Specification

Voltage AC	277 (Volt)
Nominal Frequency	50
Rated Current @ambient	20
Ambient temperature [°C]	50

Electric Specification

Leakage current (IEC60939) [mA]	0.87
Input terminal	103 - PCB push-in terminal
Output terminal	103 - push-in terminal
Resistance	680 (Kiloohm)

Attenuation Specification

CM attenuation @ 150kHz [dB]	34 (Decibels)
DM attenuation @ 150kHz [dB]	28 (Decibels)
Inductance L1 [μH]	2.4 (Millihenry)
Capacitance Cx1 [μF]	1 (Microfarad)
Capacitance Cx2 [μF]	0.47 (Microfarad)
Capacitance Cy1 [nF]	10 (Nanofarad)

Attenuation graph

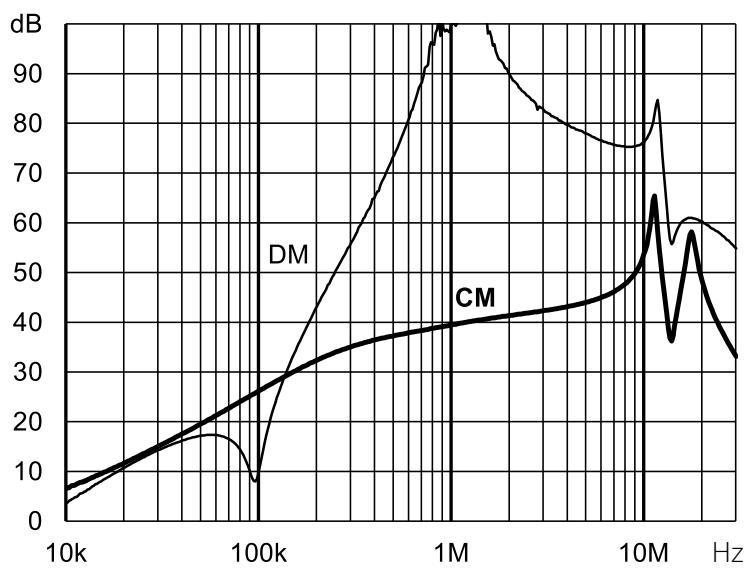

Mechanic Specification

Length [mm]	97.7
Width [mm]	59
Height [mm]	35
Volume [cm ³]	202 (Cubic Centimeter)
NetWeight [g]	270 (Gram)
Power Loss [W]	6.2 (Watt)

Schaffner schemes

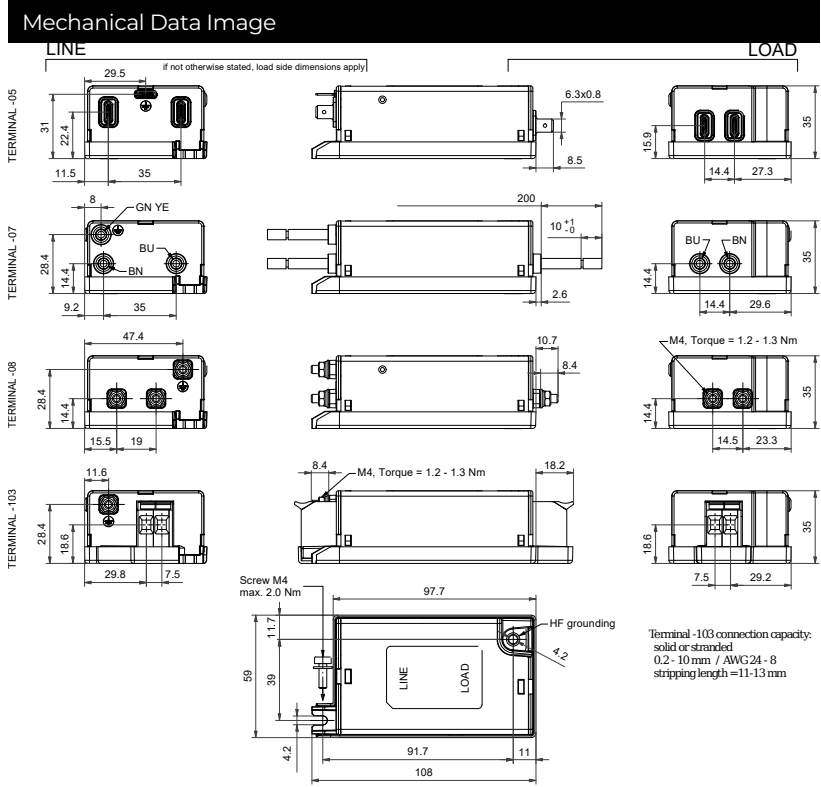

Dimensions