

FN2241-600-99-C2222-R99

SAP Code: 822899

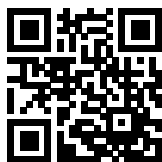

- Chassis mount
- 600 A EMC filter with bus bars
- DC

[Buy article now](#)

Family Technical Specifications

Maximum continuous operating voltage	500 VDC (FN223X) 1000 VDC (FN222X, FN224X)
Certified to	UL 60939-3, IEC 60939-3, CSA 22.2 No. 8-13
Output connections	Ni-plated busbars
Pollution degree	PD 3 acc. IEC 60664-1
Overvoltage category	II acc. IEC 60664-1
Surge withstand	DC+/DC- to PE: 4000 V (FN223X) / 6000 V (FN222X, FN224X) DC+ to DC-: 2000 V acc. to IEC 61000-4-5
Altitude	up to 2000 m no derating applies. Above 2000 m derating acc. to IEC 60664-1 applies
Operating frequency	DC
Protection category	IP00 acc. to IEC 60529
Vibration and shock	3M12 (operation) acc. to IEC 60721-3-3
Flammability corresponding to	Plastics: UL 94 V-0
MTBF	> 300,000 hours
Rated currents	600
Overload capability	6x rated current for 1 sec, once per hour 1.5x rated current for 1 minute, once per hour
Cooling	Natural convection AN
Climatic class	40/100/21 acc. to IEC 60068-1
Temperature range (operation and storage)	-40 °C to +100 °C (with current derating >55 °C)
High potential test voltage	DC+/DC- -> PE 2500 VDC for 2 s (FN223X)* DC+ -> DC- 3600 VDC for 2 s (FN222X, FN224X)* DC+ -> DC- 2000 VDC for 2 s (FN223X)* DC+/DC- -> PE 5000 VDC for 2 s (FN222X, FN224X)*

Approvals & Compliances



Features and Benefits

- FN222X, FN223X and FN224X series of filters provides state-of-the-art EMI attenuation with a choice of three performance levels
- The filters are built to fit perfectly to high power EV charging applications
- The shape allows a convenient and space-saving installation
- Fulfills the requirements in IEC/EN 61851-23 Electric vehicle conductive charging system
- Fulfills the requirements in UL 2202 Electric Vehicle (EV) Charging System Equipment
- FN224X offers voltage and performance ratings of FN222X on a smaller footprint

Typical Applications

- High Power EV DC charging beyond HPC350 (500 A @ 920 V)
- Two voltage levels (500 VDC and 1000 VDC) for CHAdeMO and CCS

Typical electrical schematic

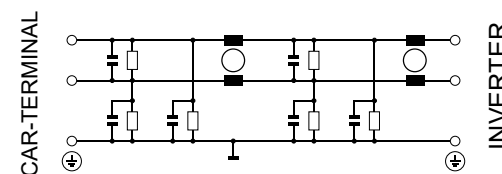

*High potential test voltage: Repetition with max. 80% of specified values

General Specification

Voltage AC	1000 (Volt)
Nominal Frequency	DC
Rated Current @ambient	600
Ambient temperature [°C]	55

Electric Specification

Input terminal	99 - special / busbar
Output terminal	99 - special / busbar
Resistance	10 (Kilohm)

Attenuation Specification

Capacitance Cy1 [nF]	330 (Nanofarad)
Capacitance Cy2 [nF]	330 (Nanofarad)

Attenuation graph

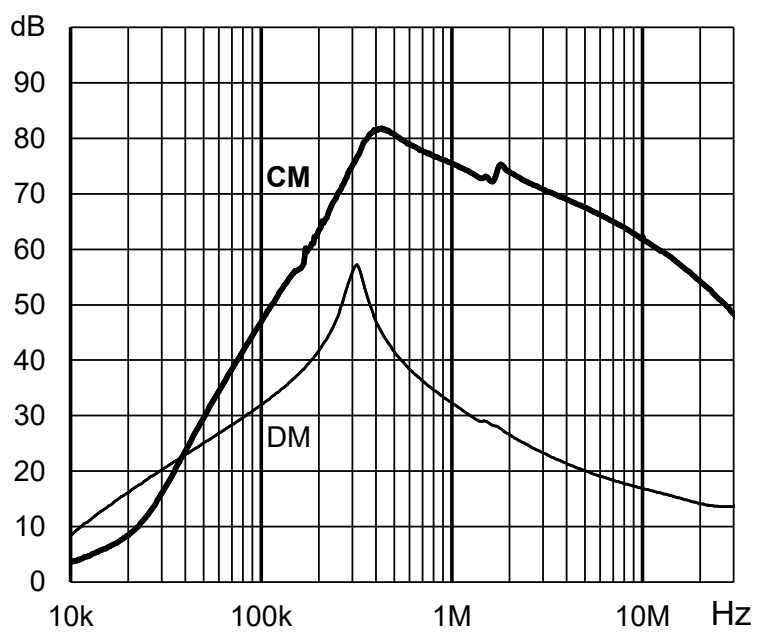

Mechanic Specification

Length [mm]	149
Width [mm]	163
Height [mm]	95
Volume [cm ³]	2307 (Cubic Centimeter)
NetWeight [g]	3420 (Gram)

Schaffner schemes

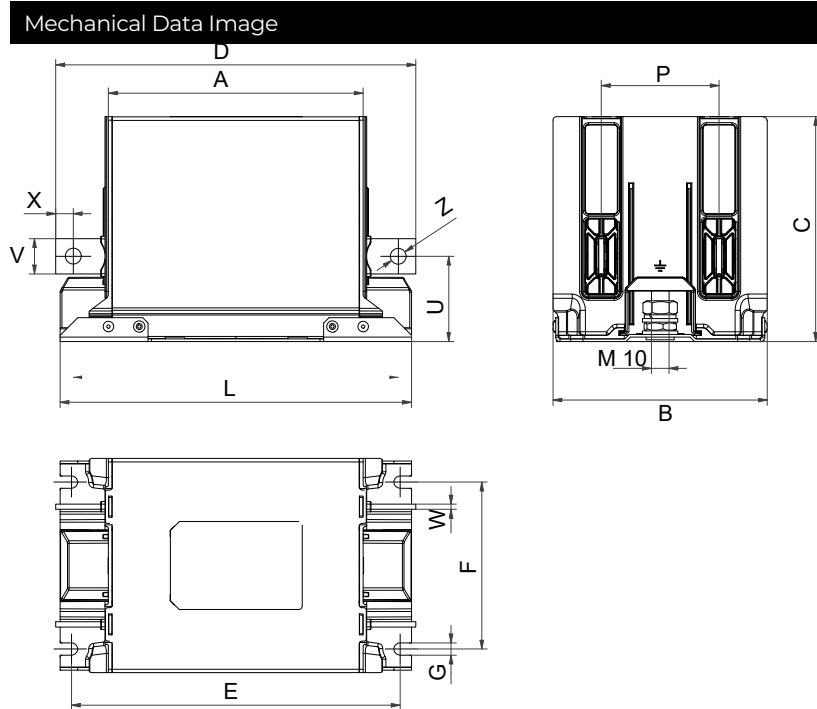

Dimensions

A [mm]	145
B [mm]	122
C [mm]	128
D [mm]	210
E [mm]	187
F [mm]	95
G [mm]	7
L [mm]	200
P [mm]	67
U [mm]	48
V [mm]	25
W [mm]	8
X [mm]	12,5
Z [mm]	11