

# ED101-1.5-5M0

SAP Code: 822547

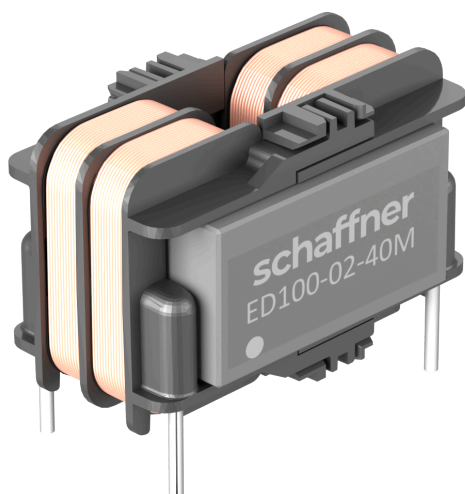
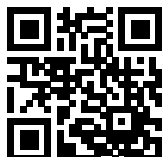

- PCB Common Mode Choke
- 1.5 A PCB Common Mode Choke with 5 mH Inductance
- General

[Buy article now](#)

## Family Technical Specifications

<b>MTBF</b>	> 13,000,000 hours acc. MIL-HDBK-217
<b>Vibration and shock</b>	3M4 acc. IEC 60721-3-3
<b>Maximum continuous operating voltage</b>	300 VAC, 50/60 Hz
<b>Altitude</b>	Derating above 2,000 m
<b>Climatic class</b>	40/125/56 acc. IEC 60068-1
<b>Creepage and clearance distances</b>	Creepage > 3 mm / Clearance > 2.5 mm between windings
<b>Overtoltage category</b>	II acc. IEC 60664-1
<b>Design corresponding to</b>	IEC 60938-1/-2
<b>Protection category</b>	IP 00
<b>Pollution degree</b>	PD2 acc. IEC 60664-1
<b>Rated currents</b>	1.5
<b>Inductance reduction (DC bias with IN)</b>	Less than 10% at rated current
<b>Cooling</b>	AN - natural convection
<b>Rated inductance</b>	3 to 40 mH common-mode
<b>Stray inductance</b>	0.1 - 3.1 mH
<b>Flammability corresponding to</b>	UL 94 V-0
<b>Operating frequency</b>	DC to 60 Hz
<b>Temperature range (operation and storage)</b>	-40°C to 125°C

## Approvals & Compliances

### RoHS

## Features and Benefits

- Increases power factor
- Combination of common- and differential-mode inductances
- Rated currents up to 2 A
- Compact and light-weight
- Small PCB footprint

## Typical Applications

- Mains operated LED drivers
- Electronic ballasts
- Input filters for switch mode power supplies

## Typical electrical schematic

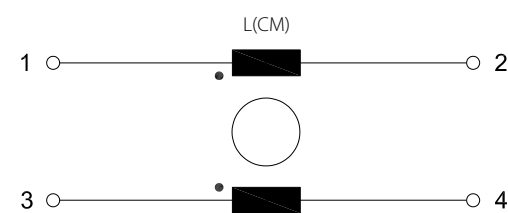

## General Specification

Voltage AC	300 (Volt)
Nominal Frequency	50
Rated Current @ambient	1.5
Ambient temperature [°C]	65

## Electric Specification

Input terminal	02 - PCB Pin
----------------	--------------

## Attenuation Specification

Inductance L1	5 (Millihenry)
---------------	----------------

Attenuation graph

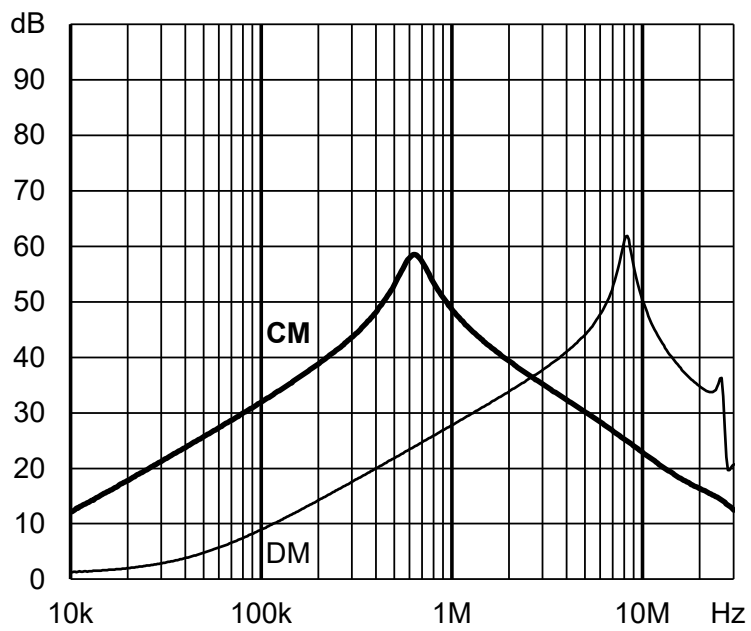

## Mechanic Specification

Length [mm]	24
Width [mm]	14.3
Height [mm]	15.3
NetWeight [g]	14 (Gram)
ø Pin [mm]	0.8

## Schaffner schemes

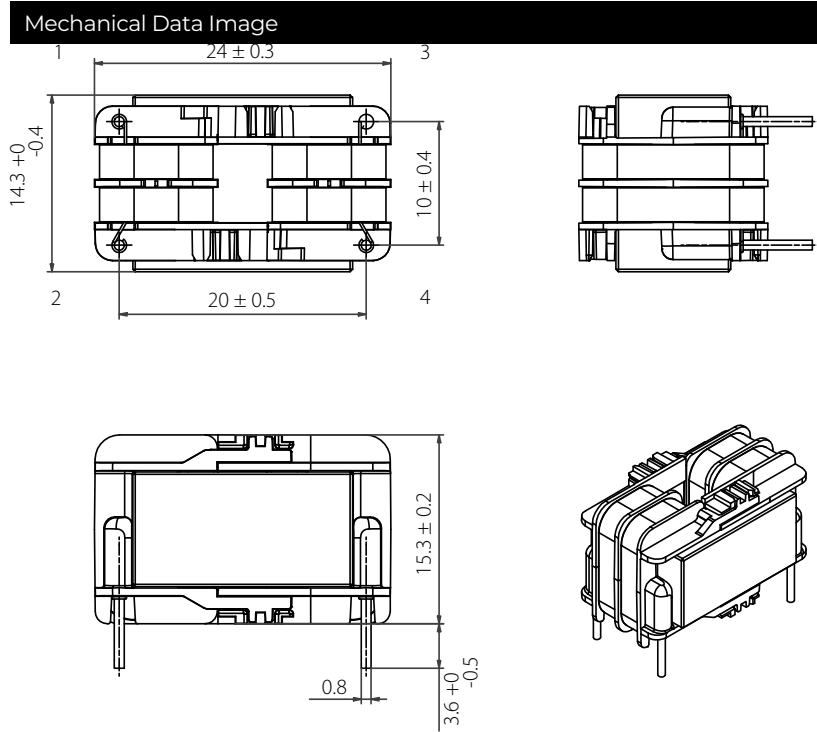

## Dimensions

H [mm]	15.3
L [mm]	24
W [mm]	14.3