

Compact EMC/RFI Filter for Industrial Motor Drive Applications



- Very compact and light weight design requiring minimum space
- Easy, time-saving installation and contacting
- Protective covers as optional accessory available
- Attenuation performance according to EN 61800-3/A11



Performance indicators

Attenuation performance

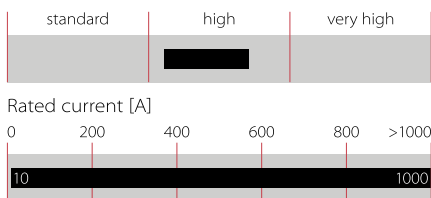

Technical specifications

Maximum continuous operating voltage	3x 520/300 VAC (480 VAC +10% possible)
Operating frequency	DC to 60 Hz
Rated currents	10 to 1000 A @ 50°C
High potential test voltage	P → E 2750 VDC for 2 sec P → P 2250 VDC for 2 sec
Protection category	IP 20 (10 to 100 A) IP 00 (150 to 1000 A)
Overload capability	4x rated current at switch on, 1.5x rated current for 1 minute, once per hour
Temperature range (operation and storage)	-25°C to +100°C (25/100/21)
Flammability corresponding to	UL 94 V-2 or better
Design corresponding to	UL 1283, CSA 22.2 No. 8 1986, IEC/EN 60939
MTBF @ 50°C/400 V (Mil-HB-217F)	>320,000 hours

Approvals & Compliances



Features and benefits

- An extremely compact and light weight filter design requiring minimum mounting space in installations and cabinets
- Simple and time-saving installation with good accessibility for automatic and hand tools
- Solid, touch-safe terminal blocks, for all filters from 10 to 100 A, offering sufficient contacting cross section according to the EN 60204-1 installation standard
- Optionally available transparent protective covers for all filters with busbars from 150 to 1000 A, to protect the installer, operator or inspector from accidental touching of live conductors. They can easily be retrofitted even if the filter is already installed and connected
- These EMC filters provide the attenuation performance needed to fulfill EN 61800-3/A11
- Guaranteed filter performance under fullload operating conditions
- 15 different filter models allow the specific choice and deployment for most industrial applications

Typical applications

- Variable speed electrical power drive systems/motor drives for mainly industrial purpose
- Various industrial applications comprising frequency inverters, motor drives and servo drives



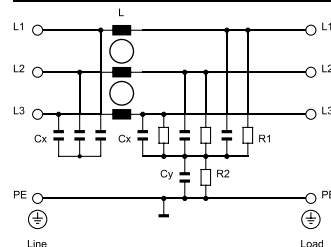



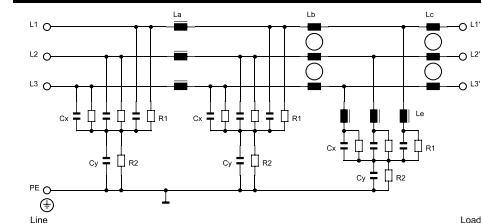









Typical electrical schematic (up to 100 A)



Typical electrical schematic (>100 A), for FN3271 refer to page 2



Filter selection table

Filter	Buy	Rated current @ 50°C (40°C)	Typical drive power rating*	Leakage current @ 520 VAC/50 Hz	Power loss @ 25°C/50 Hz	Input/Output connections		Weight [kg]	Protective covers***	
						[A]	[kW]		[mA]**	[W]
FN3270H-10-44		10 (11)	5.5	3.1	2.4	-44		0.4		
FN3270H-20-44		20 (22)	11	3.1	4.1	-44		0.5		
FN3270H-35-33		35 (38)	22	3.4	6.8	-33		0.7		
FN3270H-50-34		50 (55)	30	3.4	12.8	-34		1.2		
FN3270H-65-34		65 (71)	37	3.4	13.5	-34		1.3		
FN3270H-80-35		80 (88)	45	3.4	13.5	-35		2.2		
FN3270H-100-35		100 (110)	55	3.4	17.1	-35		2.6		
FN3270H-150-99		150 (164)	75	6.9	7.5	-99		6.1		801916
FN3270H-200-99		200 (219)	110	6.9	13.2	-99		6.1		801916
FN3270H-250-99		250 (274)	132	6.9	20.6	-99		6.1		801916
FN3270H-320-99		320 (350)	160	6.9	12.2	-99		7.2		801916
FN3270H-400-99		400 (438)	220	6.9	19.2	-99		7.2		801916
FN3270H-600-99		600 (657)	315	6.9	35.6	-99		7.7		801916
FN3270H-800-99		800 (876)	400	6.9	51.8	-99		15.8		806275
FN3270H-1000-99		1000 (1095)	560	6.9	81.0	-99		15.8		806275
FN3271H-150-99		150 (164)	75	6.9	7.5	-99		6.1		801916
FN3271H-200-99		200 (219)	110	6.9	13.2	-99		6.1		801916
FN3271H-250-99		250 (274)	132	6.9	20.6	-99		6.1		801916
FN3271H-320-99		320 (350)	160	6.9	12.2	-99		7.2		801916
FN3271H-400-99		400 (438)	220	6.9	19.2	-99		7.2		801916
FN3271H-600-99		600 (657)	315	6.9	35.6	-99		7.7		801916
FN3271H-800-99		800 (876)	400	6.9	51.8	-99		15.8		806275
FN3271H-1000-99		1000 (1095)	560	6.9	81.0	-99		15.8		806275

* Calculated at rated current, 480 VAC and cos phi=0.8. The exact value depends upon the efficiency of the drive, the motor and the entire application.

** Standardized calculated leakage current acc. IEC60939 under normal operating conditions.

*** Please contact your local Schaffner partner to order the optional protective covers with the order code in the table above.

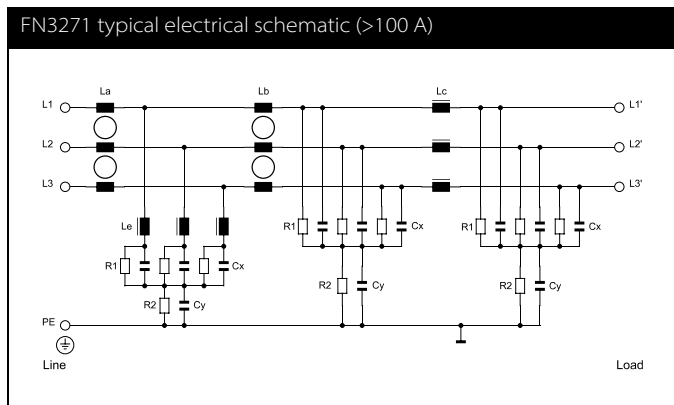

FN3271H description

- FN3271H can be used for applications where a differential mode choke is needed on the load side.
- In general FN3271H is a mirrored version of the high current FN3270H (>100A).
- PE is not mirrored and is still available on line side, due to safety measures.
- In 50/50 Ohm measurement for insertion loss no difference can be detected.

Typical filter attenuation

Per CISPR 17; A=50 Ω/50 Ω sym; B=50 Ω/50 Ω asym; C=0.1 Ω/100 Ω sym; D=100 Ω/0.1 Ω sym

10 and 20 A types

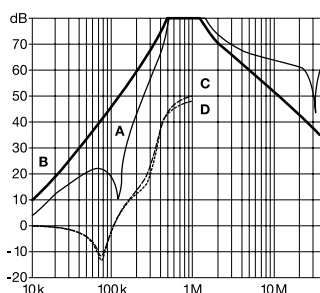

35 to 65 A types

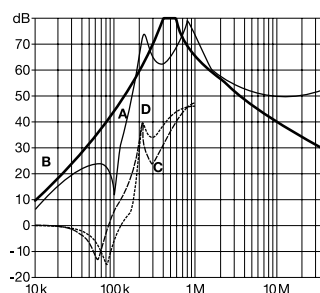

80 and 100 A types

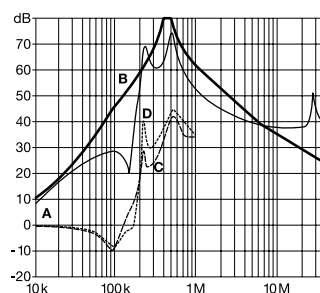

150 to 1000 A types

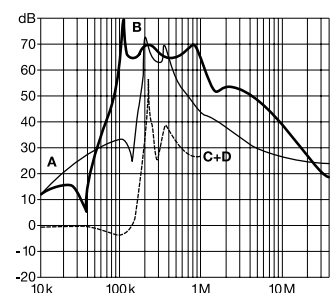

Mechanical data

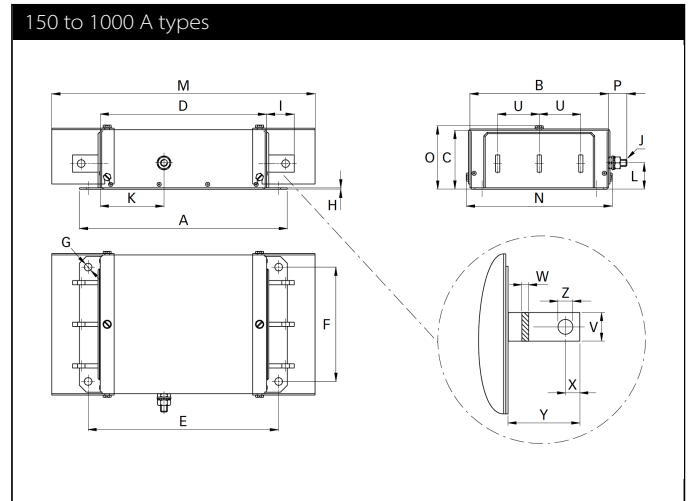
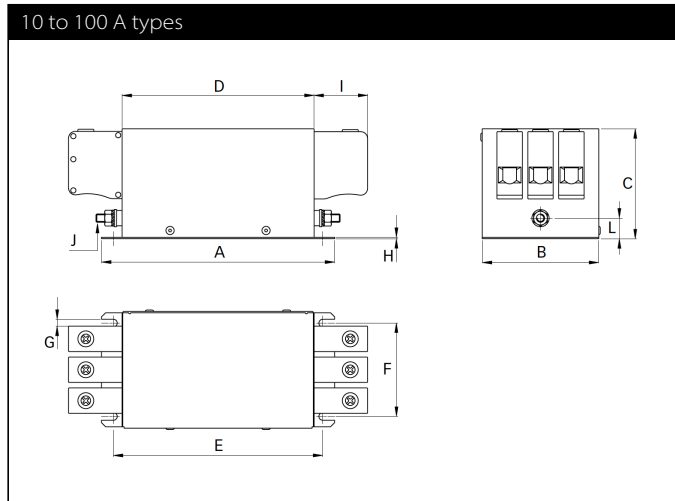

Dimensions

	10 A	20 A	35 A	50 A	65 A	80 A	100 A	150 A	200 A	250 A	320 A	400 A	600 A	800 A	1000 A
A	150	150	160	170	170	200	230	300	300	300	300	300	300	370	370
B	58	58	70	85	85	95	95	200	200	200	200	200	200	190	190
C	58	58	68	80	80	90	90	86	86	86	86	86	86	125	125
D	120	120	130	140	140	170	200	240	240	240	240	240	240	310	310
E	132.5	132.5	142.5	152.5	152.5	182.5	212.5	275	275	275	275	275	275	345	345
F	42	42	50	65	65	75	75	165	165	165	165	165	165	155	155
G	4.5	4.5	5.5	5.5	5.5	5.5	5.5	Ø11	Ø11	Ø11	Ø11	Ø11	Ø11	Ø11	Ø11
H	1	1	1	1	1	1.5	1.5	2	2	2	2	2	2	3	3
I	22	22	25	39	39	45	45	40	40	40	40	40	40	50	50
J	M4	M4	M5	M6	M6	M8	M8	M10	M10	M10	M10	M10	M10	M12	M12
K								92	92	92	92	92	92	138	138
L	20.5	20.5	20	15	15	16	16	37	37	37	37	37	37	67	67
M								380	380	380	380	380	380	610	610
N								211	211	211	211	211	211	201	201
O								93	93	93	93	93	93	132	132
P								26.5	26.5	26.5	26.5	26.5	26.5	29	29
U								60	60	60	60	60	60	60	60
V								20	20	20	25	25	25	40	40
W								3	3	3	6	6	8	8	8
X								10	10	10	12.5	12.5	12.5	20	20
Y								37	37	37	37	37	37	47	47
Z								Ø9	Ø9	Ø9	Ø11	Ø11	Ø11	Ø13.5	Ø13.5

All dimensions in mm; 1 inch = 25.4 mm
Tolerances according: ISO 2768-m/EN 22768-m

Filter input/output connector cross sections

	-33	-34	-35	-44
Solid wire	16 mm ²	35 mm ²	50 mm ²	10 mm ²
Flex wire	10 mm ²	25 mm ²	50 mm ²	6 mm ²
AWG type wire	AWG 6	AWG 2	AWG 1/0	AWG 8
Recommended torque	1.5-1.8 Nm	4.0-4.5 Nm	7-8 Nm	1.0-1.2 Nm

Please visit www.schaffner.com to find more details on filter connectors.

Accessories

Protective Cover for Busbar Filters

Construction schematic

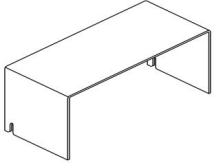

Installation example

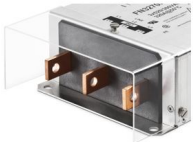

Applicable Busbar Filters

FN3359

FN3270



Transparent protective covers for FN3359 and FN3270 with busbars from 150 to 1000 A

Protection for the operator or inspector from accidental touching of live conductors.

Easily to be added after the filter has been installed and connected.

[Datasheet PDF >](#)

Surge Protection Devices



SPD with a fail safe function to prevent short-circuit (separation of circuit and element is visually confirmable)

Compliance with IEC 61643-1 that meets the new JIS standards

Against indirect lightning surge for single phase / three phase power supplies Quick response for surge

Impulse current capacity 8/20 μ s-5,000A

Impulse test category: Class II (Type II)

Every pathway consists of same elements. Between line and line/between lines and ground can protect as the same level.

[Datasheet PDF >](#)



Headquarters, global innovation and development

Switzerland

Schaffner Group

Industrie Nord
Nordstrasse 11e
4542 Luterbach
T +41 32 681 66 26
info@schaffner.com



Sales and application centers

China

Schaffner EMC Ltd. Shanghai

T20-3 C, No 565 Chuangye Road,
Pudong district
201201 Shanghai
T +86 21 3813 9500
cschina@schaffner.com
www.schaffner.com.cn

Finland

Schaffner Oy

Sauvonrinne 19 H
08500 Lohja
T +358 50 468 7284
finlandsales@schaffner.com

France

Schaffner EMC S.A.S.

16-20 Rue Louis Rameau
95875 Bezons
T +33 1 34 34 30 60
F +33 1 39 47 02 28
francesales@schaffner.com

Germany

Schaffner Deutschland GmbH

Schoemperlenstrasse 12B
76185 Karlsruhe
T +49 721 56910
F +49 721 569110
germanysales@schaffner.com

India

Schaffner India Pvt. Ltd

REGUS WORLD TRADE CENTRE
WTC, 22nd Floor Unit No 2238, Brigade
Gateway Campus, 26/1, Dr. Rajkumar Road
Malleshwaram (W)
560055 Bangalore
T +91 80 67935355
indiasales@schaffner.com

Italy

Schaffner EMC S.r.l.

Via Ticino, 30
20900 Monza (MB)
T +39 039 21 41 070
italysales@schaffner.com

Japan

Schaffner EMC K.K.

Taiju-Seimei Sangenjaya Bldg.
1-32-12, Kamiyuma, Setagaya-ku
154-0011 Tokyo
T +81 3 5712 3650
F +81 3 5712 3651
japansales@schaffner.com
www.schaffner.jp

Singapore

Schaffner EMC Pte Ltd.

#05-09, Kg Ubi Ind. Estate
408705 Singapore
T +65 6377 3283
F +65 6377 3281
singaporesales@schaffner.com

Spain

Schaffner EMC España

Calle Caléndula 93, Miniparc III, Edificio E
El Soto de Moraleja, Alcobendas
28109 Madrid
T +34 917 912 900
F +34 917 912 901
spainsales@schaffner.com

Sweden

Schaffner EMC AB

Östermalmstorg 1
114 42 Stockholm
T +46 8 5050 2425
swedensales@schaffner.com
www.schaffner.com

Switzerland

Schaffner EMV AG

Industrie Nord
Nordstrasse 11e
4542 Luterbach
T +41 32 681 66 88
T +41 32 681 66 26
switzerlandsales@schaffner.com

Taiwan

Schaffner EMV Ltd.

20 Floor-2, No 97, Section 1, XinTai 5th Road
22175 XiZhi District New Taipei City 22175
T +886 2 2697 5500
F +886 2 2697 5533
taiwansales@schaffner.com
www.schaffner.com.tw

Thailand

Schaffner EMC Co. Ltd.

Northern Region Industrial Estate
67 Moo 4 Tambon Ban Klang
Amphur Muangng P.O. Box 14
51000 Lamphun
T +66 53 58 11 04
F +66 53 58 10 19
thailandsales@schaffner.com

United Kingdom

Schaffner Ltd.

1, Oakmede Place
Binfield
RG42 4JF Berkshire
T +44 118 9770070
F +44 118 9792969
uksales@schaffner.com

USA

Schaffner EMC Inc.

52 Mayfield Avenue
Edison, New Jersey
T +1 732 225 9533
F +1 732 225 4789
usasales@schaffner.com
www.schaffnerusa.com

To find your local partner within Schaffner's global network: www.schaffner.com

© 2020 Schaffner Group

The content of this document has been carefully checked and understood. However, neither Schaffner nor its subsidiaries assume any liability whatsoever for any errors or inaccuracies of this document and the consequences thereof. Published specifications are subject to change without notice. Product suitability for any area of application must ultimately be determined by the customer. In all cases, products must never be operated outside their published specifications. Schaffner does not guarantee the availability of all published products. This disclaimer shall be governed by substantive Swiss law and resulting disputes shall be settled by the courts at the place of business of Schaffner Holding AG. Latest publications and a complete disclaimer can be downloaded from the Schaffner website. All trademarks recognized.